

Operator's Manual

Root[®]



For Sale in the USA

These operating instructions provide the necessary information for proper operation of all models of the Root[®]. There may be information provided in this manual that is not relevant for your system. General knowledge of pulse oximetry and an understanding of the features and functions of Root are prerequisites for its proper use. Do not operate Root without completely reading and understanding these instructions.

Note: Purchase or possession of this device does not carry any express or implied license to use with replacement parts which would, alone or in combination with this device, fall within the scope of one of the relating patents.

Note: Cleared Use Only: The device and related accessories are cleared by the Food and Drug Administration (FDA) and are CE Marked for noninvasive patient monitoring and may not be used for any processes, procedures, experiments, or any other use for which the device is not intended or cleared by the applicable regulatory authorities, or in any manner inconsistent with the directions for use or labeling.

CAUTION: Federal (USA) law restricts this device to sale by or on the order of a physician. See instructions for use for full prescribing information, including indications, contraindications, warnings and precautions.

Wireless Radio
FCC ID:VKF-RDS7A IC:7362A-RDS7A IC Model: RDS7A

Masimo Corporation
52 Discovery
Irvine, CA 92618, USA
Tel.: 949-297-7000
Fax.: 949-297-7001
www.masimo.com



EU authorized representative for Masimo Corporation:



MDSS GmbH
Schiffgraben 41
D-30175 Hannover, Germany

MEDICAL ELECTRICAL EQUIPMENT



WITH RESPECT TO ELECTRIC SHOCK, FIRE AND MECHANICAL HAZARDS ONLY IN ACCORDANCE WITH

3149433

Conforms to ANSI/AAMI ES 60601-1, CAN/CSA C22.2 No. 60601-1, and applicable Particular (IEC 60601-2-49, ISO 80601-2-56) and related Collateral (IEC 60601-1-8:2006) Standards for which the product has been found to comply by Intertek.

Patents: www.masimo.com/patents

® Iris, Masimo, MOC-9, PVi, Radical-7, Radius-7, rainbow, Root, RRa, SedLine, SET, Signal Extraction Technology, SpCO, SpHb, and SpMet are federally registered trademarks of Masimo Corporation.

ISA, MyView, and SpOC are trademarks of Masimo Corporation.

The use of the trademark Patient SafetyNet is under license from University HealthSystem Consortium.

All other trademarks and registered trademarks are property of their respective owners.

© 2018 Masimo Corporation

Contents

About This Manual	7
Product Description and Features, Intended Use and Indications for Use	9
Product Description and Features	9
Intended Use	9
Indications for Use	9
Contraindication	10
Safety Information, Warnings, and Cautions	11
Safety Warnings and Cautions	11
Performance Warnings and Cautions	12
Cleaning and Service Warnings and Cautions	14
Compliance Warnings and Cautions	14
Chapter 1: Description	17
Features	17
Chapter 2: Setting Up	21
Unpacking and Inspection	21
Guidelines for Setting Up	21
Power On	22
Initial Battery Charging	23
Radical-7 Connection	24
Radius-7 Connection	25
MOC-9 Connection	25
Nurse Call Connection	26
Masimo Kite	27
Bluetooth Devices	27
Chapter 3: Operation	29
About the Main Screen	29
About the Status Bar	30
About the Action Bar	32
Using the Touchscreen Interface	33
Menu Navigation	36
Understanding Windows	38

- Accessing Main Menu Options -----46
- Alarm Interface-----63
- Trend Download-----68
- Session Management -----68
- Screen Capture -----69
- Lights ----- 71
- Chapter 4: Admit and Discharge to Patient SafetyNet----- 75
 - Not Admitted ----- 75
 - Admitting a Patient ----- 76
 - Discharging a Patient ----- 77
 - Not Monitoring Message ----- 79
 - Monitoring Resumed Message----- 80
- Chapter 5: Electronic Medical Record (EMR) Push ----- 81
 - Determining EMR Push is Active----- 81
 - Manually Entering Patient Data----- 81
 - Sending Patient Data to the EMR-----82
- Chapter 6: Radical-7 -----83
- Chapter 7: Radius-7-----85
- Chapter 8: MOC-9 ----- 87
 - Using MOC-9 Ports ----- 87
- Chapter 9: Iris-----89
 - Using Iris Connectivity Ports ----- 90
 - Iris Icon ----- 91
 - Iris Screen -----92
- Chapter 10: Bluetooth Devices-----95
 - Connect Device to Root -----95
- Chapter 11: Messages----- 97
- Chapter 12: Troubleshooting -----99
 - Troubleshooting Radical-7, Radius-7, and MOC-9 Modules-----99
 - Troubleshooting Root -----99
- Chapter 13: Specifications ----- 103
 - Alarms ----- 103
 - Nurse Call Specifications ----- 103

Connectors ----- 103

Electrical----- 104

Environmental----- 104

Touchscreen Display----- 105

Wireless Specifications----- 105

Compliance----- 107

Guidance and Manufacturer's Declaration-Electromagnetic Emissions----- 108

Guidance and Manufacturer's Declaration-Electromagnetic Immunity ----- 109

Recommended Separation Distances ----- 111

Symbols----- 112

Chapter 14: Service and Maintenance ----- 115

 Cleaning ----- 115

 Replacing the Fuses ----- 115

 Power-On Self Test----- 115

 Nurse Call Setting Connections ----- 116

 Battery Test ----- 116

 Repair Policy----- 116

 Return Procedure----- 117

 Masimo Technical Services----- 117

 Contacting Masimo ----- 117

Index ----- 121

About This Manual

This manual explains how to set up and use Root[®]. Important safety information relating to general use of Root appears in this manual. Read and follow any warnings, cautions, and notes presented throughout this manual. The following are explanations of warnings, cautions, and notes.

A *warning* is given when actions may result in a serious outcome (for example, injury, serious adverse effect, death) to the patient or user.

WARNING: This is an example of a warning statement.

A *caution* is given when any special care is to be exercised by the patient or user to avoid injury to the patient, damage to this device, or damage to other property.

CAUTION: This is an example of a caution statement.

A *note* is given when additional general information is applicable.

Note: This is an example of a note.

Product Description and Features, Intended Use and Indications for Use

Product Description and Features

Root® is a patient monitoring and connectivity platform. It offers multiple high-impact innovations for broad applications across the continuum of care.

- Instantly interpretable, high-visibility display of Masimo's breakthrough SET® and rainbow® SET measurements.
- Intuitive, touchscreen navigation for easy and adaptable use in any hospital environment.
- Flexible measurement expansion through Masimo Open Connect (MOC-9®).
- Designed for third-party measurement expansion to allow other companies to add to the platform measurements.
- Built-in network connectivity gateway through Iris® for standalone devices such as IV pumps, ventilators, beds, and other patient monitors.
- Docking and charging station for Radical-7® and Radius-7® Battery Module.
- Ability to display data on a secondary display.
- Ability to display data from external devices using Bluetooth.

For all prescribing information and instructions for use of the compatible medical devices that are connected to Root, see Operator's Manual or Instructions for Use for the specific medical device.

Intended Use

The Masimo Root Monitoring System is indicated for use by healthcare professionals for the monitoring of multiple physiological parameters in healthcare environments.

The Masimo Root Monitoring System can transmit data for supplemental remote viewing and alarming (e.g., at a central station).

The Masimo Root Monitoring System can be used with the optional Radical-7, ISA product family, Radius-7, and/or the SedLine module.

The Masimo Root Monitoring System is intended to be used with connected measurement modules compatible with Root interfaces.

Indications for Use

The Masimo Root Monitoring System is indicated for use by healthcare professionals for the monitoring of multiple physiological parameters in healthcare environments.

The Masimo Root Monitoring System can transmit data for supplemental remote viewing and alarming (e.g., at a central station).

The optional Masimo Radical-7 Pulse CO-Oximeter and Accessories are indicated for the continuous noninvasive monitoring of functional oxygen saturation of arterial hemoglobin (SpO₂), pulse rate, carboxyhemoglobin saturation (SpCO), methemoglobin saturation

(SpMet), total hemoglobin concentration (SpHb), and/or respiratory rate (RRa). The Masimo Radical-7 Pulse CO-Oximeter and accessories are indicated for use with adult, pediatric, and neonatal patients during both no motion and motion conditions, and for patients who are well or poorly perfused in hospitals, hospital-type facilities, mobile, and home environments. In addition, the Masimo Radical-7 Pulse CO-Oximeter and accessories are indicated to provide the continuous noninvasive monitoring data obtained from the Masimo Radical-7 Pulse CO-Oximeter and accessories of functional oxygen saturation of arterial hemoglobin (SpO₂) and pulse rate to multi-parameter devices for the display of those devices.

The optional Masimo Radius-7 Wearable Pulse CO-Oximeter and Accessories are indicated for the continuous noninvasive monitoring of functional oxygen saturation of arterial hemoglobin (SpO₂), pulse rate, carboxyhemoglobin saturation (SpCO), methemoglobin saturation (SpMet), total hemoglobin concentration (SpHb), and/or respiratory rate (RRa). The Masimo Radius-7 Wearable Pulse CO-Oximeter and accessories are indicated for use with adult and pediatric patients during both no motion and motion conditions, and for patients who are well or poorly perfused in hospitals and hospital-type facilities.

The optional ISA product family consists of three types of sidestream gas analyzers (ISA CO₂, ISA AX+ and ISA OR+), intended to be connected to other medical backboard devices for monitoring of breath rate and the following breathing gases:

ISA CO₂: CO₂

ISA AX+: CO₂, N₂O, Halothane, Isoflurane, Enflurane, Sevoflurane and Desflurane

ISA OR+: CO₂, O₂, N₂O, Halothane, Isoflurane, Enflurane, Sevoflurane and Desflurane

ISA CO₂, ISA AX+ and ISA OR+ are intended to be connected to a patient breathing circuit for monitoring of inspired/expired gases during anesthesia, recovery and respiratory care. The intended environment is the operating suite, intensive care unit and patient room. ISA CO₂ is also intended to be used in road ambulances. The intended patient population is adult, pediatric and infant patients.

The optional SEDLine Sedation Monitor is indicated for use in the operating room (OR), intensive care unit (ICU), and clinical research laboratory. It is intended to monitor the state of the brain by real-time data acquisition and processing of EEG signals. The system includes the Patient State Index (PSi), a proprietary computed EEG variable that is related to the effect of anesthetic agents

Contraindication

There are no contraindications.

Safety Information, Warnings, and Cautions

CAUTION: Root is to be operated by, or under the supervision of, qualified personnel only. The manual, accessories, directions for use, all precautionary information, and specifications should be read before use. Refer to Operator's Manuals for ISA, Kite, Patient SafetyNet, Radical-7, Radius-7, and SedLine for additional safety information, warnings, and cautions.

Safety Warnings and Cautions

WARNING: Do not use Root if it appears or is suspected to be damaged.

WARNING: Do not adjust, repair, open, disassemble or modify Root. Injury to personnel or equipment damage could occur. Return Root for servicing.

WARNING: Do not use Root during or nearby magnetic resonance imaging (MRI) or in an MRI environment.

WARNING: Do not place Root or accessories in any position that might cause it to fall on the patient.

WARNING: To ensure safety, avoid stacking multiple devices or placing anything on the device during operation.

WARNING: Do not use Root in the presence of flammable anesthetics or other flammable substance in combination with air, oxygen-enriched environments or nitrous oxide to avoid risk of explosion.

WARNING: To reduce the risk of explosion, only replace battery with Masimo supplied parts.

WARNING: Do not start or operate the Root unless the setup was verified to be correct.

WARNING: To ensure safety, only use Masimo authorized devices with Root.

WARNING: To protect against fire hazard, replace only with recommended fuses of the same type, current rating, and voltage rating.

WARNING: Do not remove the back panel of the device. This could cause injury to personnel or device damage.

WARNING: Electrical Shock Hazard: To protect against injury, follow the directions below:

- Avoid placing the device on surfaces with visible liquid spills.
- Do not soak or immerse the device in liquids.
- Do not attempt to sterilize the device.
- Use cleaning solutions only as instructed in this Operator's Manual.
- Do not attempt to clean the Root while monitoring patient.

WARNING: Do not plug in or remove the power cord with wet hands to avoid risk of electric shock. Ensure that your hands are clean and dry before touching the power cord.

WARNING: When positioned on a flat surface, the device should be secured with a mounting system recommended by Masimo.

WARNING: As with all medical equipment, carefully route patient cables to reduce the possibility of patient entanglement or strangulation.

CAUTION: Do not place the Root where the controls can be changed by the patient.

CAUTION: To ensure patient isolation, connect only Masimo devices that have been designed for Root.

CAUTION: Equipment intended to be connected to signal input/signal output ports should comply with applicable electrical safety standards to further minimize the risk of electric shock. Only devices that have been configured to operate with Root may function properly when connected.

CAUTION: Only use the AC power cable provided by Masimo. Using a different AC power cable could cause damage to Root. Check the power cord and plug to ensure that it is intact and undamaged.

CAUTION: To avoid risk of electrical shock, this equipment must only be connected to a supply mains with a protective earth connection. Do not under any circumstances remove the grounding conductor from the power plug.

CAUTION: Use a grounded outlet for proper equipment grounding. A hospital-grade outlet is required.

CAUTION: Do not place Root where the appliance inlet or the AC power plug cannot be readily disconnected.

Note: Disconnect the device from AC mains by removing the AC power cord connector from the device inlet.

Note: If there is any doubt about the integrity of the protective earth conductor arrangement, operate Root on internal battery power until the AC power supply protective conductor is fully functional.

Note: Do not monitor more than a single patient at a time on Root.

Note: It is recommended that Root is attached to an AC power source when it is not in use to ensure that the battery remains fully charged.

Note: For medical technologies that require AC power, the battery should be adequately charged to ensure backup power in case of AC power disruption.

Performance Warnings and Cautions

WARNING: Root should not be used as the sole basis for medical decisions. It must be used in conjunction with clinical signs and symptoms.

WARNING: Root may be used during defibrillation. This may affect the accuracy or availability of the parameters and measurements.

WARNING: Root may be used during electrocautery. This may affect the accuracy or availability of the parameters and measurements.

WARNING: Wireless communication of alarms to a secondary monitoring station should not be relied upon as a primary alarm.

WARNING: Do not place the Root against a surface that may cause the alarm to be muffled.

WARNING: Radical-7 may not fully charge in a high ambient temperature environment.

WARNING: Always ensure settings including alarms are appropriate for each patient prior to use.

WARNING: When using multiple devices in the same or similar environment, use of the same patient profile (including the same alarm presets) to avoid confusion that can lead to patient harm.

CAUTION: Ensure the speaker is not covered.

CAUTION: Before using Root under high intensity surgical lights, confirm that the display settings allow for clear display of measurements.

CAUTION: Do not connect to an electrical outlet controlled by a wall switch or dimmer.

CAUTION: Do not place the Root on electrical equipment that may affect the device, preventing it from working properly.

CAUTION: Failure to charge Root promptly after a Low Battery alarm may result in the device shutting down.

CAUTION: To minimize radio interference, other electrical equipment that emits radio frequency transmissions should not be in close proximity to Root.

CAUTION: If the Radical-7 or Radius-7 stops communicating with Root, parameters and measurements will not show on the Root; however, this will not affect Radical-7's or Radius-7's ability to monitor the patient.

CAUTION: In order to establish and maintain Root's minimum Quality of Service, the following network specifications should be met before and after installation:

- **Wired Network Connection**
During Ping Test, passing result if:
 - a. At least 98% of packets have latency \leq 30 milliseconds, and
 - b. No more than 2 % packets loss.
- **Wireless Network Connection**
During Ping Test, passing result if:
 - a. At least 98% of packets have latency \leq 100 milliseconds,
 - b. No more than 2 % packets loss, and
 - c. Primary access point signal strength at least -67 dBm.

CAUTION: The wireless quality of services may be influenced by the presence of other devices that may create radio frequency interference (RFI). Some RFI devices to consider are as follows: electrocautery equipment, cellular telephones, wireless PC and tablets, pagers, RFID, MRI, electrically powered wheelchair, etc. When used in the presence of potential RFI devices, consideration should be taken to maximize separation distances and to observe for any potential signs of interference such as loss of communication or reduced Wi-Fi signal strength.

Note: Root is provided with a Wi-Fi signal indicator as an indication of Wi-Fi communication.

Note: Root's alarm capabilities have been designed to be independent of the Wi-Fi communication feature in order to preserve Root's primary alarms.

Kite

WARNING: When using Root the Kite accessory does not generate or manage alarms. The Root alarms, used in conjunction with clinical signs and symptoms, are the primary sources for determining that an alarm condition exists.

CAUTION: Kite is not a primary display. Medical decisions should be made using data from the primary display of a device in conjunction with clinical signs and symptoms.

Patient SafetyNet System

Note: The wireless communication status between Root and Patient SafetyNet is displayed by Patient SafetyNet.

Cleaning and Service Warnings and Cautions

WARNING: Electrical Shock Hazard: The Root battery should be installed and/or removed from Root only by qualified personnel.

WARNING: Do not use petroleum-based or acetone solutions, or other harsh solvents, to clean the Root. These substances affect the device's materials and device failure can result.

CAUTION: Do not touch, press, or rub the display panels with abrasive cleaning compounds, instruments, brushes, rough-surface materials, or bring them into contact with anything that could scratch the display.

CAUTION: Do not submerge the Root in any cleaning solution or attempt to sterilize by autoclave, irradiation, steam, gas, ethylene oxide or any other method. This will seriously damage the device.

CAUTION: Electrical shock and flammability hazard: Before cleaning, always turn off the device and disconnect from any AC power source.

CAUTION: An operator may only perform maintenance procedures specifically described in the manual. Refer servicing to qualified service personnel trained in the repair of this equipment.

CAUTION: Electrical Shock Hazard: Carry out periodic tests to verify that leakage currents of patient-applied circuits and the system are within acceptable limits as specified by the applicable safety standards. The summation of leakage currents must be checked and in compliance with IEC 60601-1 and UL60601-1. The system leakage current must be checked when connecting external equipment to the system. When an event such as a component drop of approximately 1 meter or greater or a spillage of blood or other liquids occurs, retest before further use. Injury to personnel could occur.

Note: Excessive cleaning solution can flow into the device and cause damage to internal components.

Compliance Warnings and Cautions

WARNING: Changes or modifications not expressly approved by Masimo shall void the warranty for this equipment and could void the user's authority to operate the equipment.

WARNING: Do not incinerate the battery.

WARNING: In accordance with international telecommunication requirements, the frequency band of 2.4 GHz and 5.15 to 5.25 GHz is only for indoor usage to reduce potential for harmful interference to co-channel mobile satellite systems.

CAUTION: Consideration to the compliance of the IEC 60601-1-1 standard should be made when configuring Root as part of a Medical System.

CAUTION: Disposal of Product: Comply with local laws in the disposal of the device and/or its accessories.

Note: Use Root in accordance with the Environmental Specifications section in the Operator's Manual.

Note: This device complies with Part 15 of the FCC Rules. Operation is subject to the following two conditions: (1) This device may not cause harmful interference, and (2) this device must accept any interference received, including interference that may cause undesired operation.

Note: This equipment has been tested and found to comply with the limits for a Class A digital device, pursuant to part 15 of the FCC Rules. These limits are designed to provide reasonable protection against harmful interference when the equipment is operated in a commercial environment. This equipment generates, uses and can radiate radio frequency energy and, if not installed and used in accordance with the instruction manual, may cause harmful interference to radio communications. Operation of this equipment in a residential area is likely to cause harmful interference in which case the user will be required to correct the interference at his own expense.

In order to maintain compliance with FCC regulations, shielded cables must be used with this equipment. Operation with non-approved equipment or unshielded cables is likely to result in interference to radio and TV reception. If this equipment does cause harmful interference to radio or television, which can be determined by turning the equipment off and on, the user is encouraged to try to correct the interference by one or more of the following measures:

- Reorient or relocate the receiving antenna.
- Increase the separation between the equipment and receiver.
- Connect the equipment into an outlet on a circuit different from that to which the receiver is connected.
- Consult the dealer or an experienced radio/TV technician for help.

Note: To satisfy RF exposure requirements, this device and its antenna must operate with a separation distance of at least 20 cm from all persons and must not be co-located or operating in conjunction with any other antenna or transmitter.

Note: This equipment has been tested and found to comply with the Class A limits for medical devices according to the EN 60601-1-2: 2007, Medical Device Directive 93/42/EEC. These limits are designed to provide reasonable protection against harmful interference in a hospital environment.

Note: This Class A digital apparatus complies with Canadian ICES-003.

Note: Root is not intended for use during patient transport outside the healthcare facility.

Chapter 1: Description

Root can be used in the following ways:

- As a docking station and charger for Radical-7 and Radius-7 Battery Module.
- As a bedside monitoring display for parameters on Radical-7, Radius-7, and MOC-9 modules.
- As a connectivity gateway for standalone devices.

Features

Front View



Ref.	Feature	Description
1	Docking Station	Provides a docking station for the Radical-7 and Radius-7 (Note: Battery Charging Adapter required for Radius-7). While docked, the Radical-7 can communicate monitored parameters and measurements.*
2	Root Display and Touchscreen	Provides a frontal display and interface for user interactions.
3	Home Button	Provides access to the Main Screen.
4	Root Charging Indicator	Shows an indication of the battery charge for Root.

Ref.	Feature	Description
5	AC Power Indicator	Shows an indication of AC power connection Root.
6	Radical-7 Charging Indicator	Shows an indication of battery charge for the Radical-7 in the Docking Station.

**Only the touchscreen version of the Radical-7 is able to communicate monitored parameters and measurements. All other versions can only charge in the docking station but not communicate with Root.*

Back View

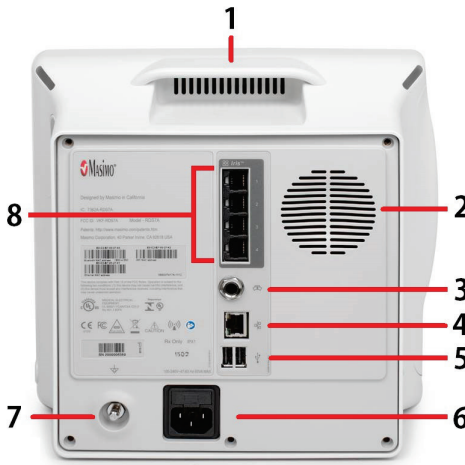

Ref.	Feature	Description
1	Handle	Allows the user to transport Root.
2	Speaker	Provides audible notification.
3	Nurse Call Connector	Provides a connection to a Nurse Call system.
4	Ethernet Port	Provides a network connection to Root using an RJ-45 cable.

Ref.	Feature	Description
5	USB Ports (2)	Provide USB 2.0 connectivity.
6	Power Entry Module	Contains the input connector for a hospital grade AC power cord and the fuse holder.
7	Equipotential Ground Connector	Provides optional functional earthing for Root to eliminate potential differences. The use of the Equipotential Ground Connector should be in accordance with IEC 60601-1.
8	Iris Connectivity Ports (4)	Provide connection for standalone devices.

Side Views

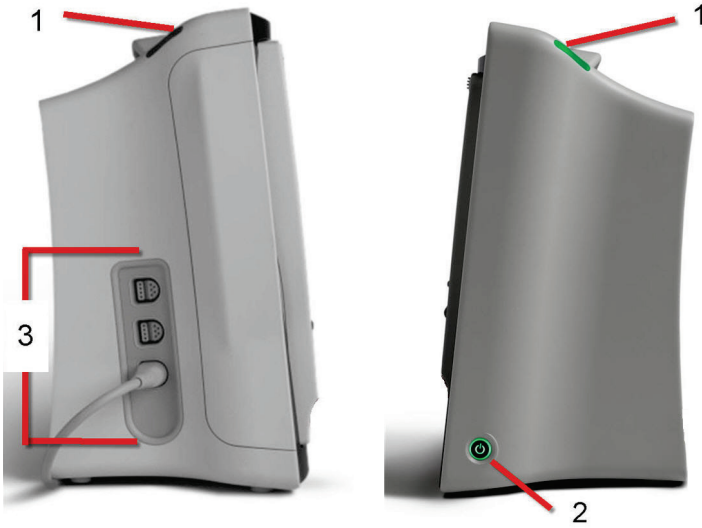

Left Side

Right Side

Ref.	Feature	Description
1	System Status Lights	Provides an indication of system messages and alarm priority. See System Status Lights on page 71.
2	Power Button	Places Root in Power On, Sleep and Power Off modes.
3	MOC-9 Ports (3)	Provide connectivity for MOC-9 modules.

Chapter 2: Setting Up

Unpacking and Inspection

To unpack and inspect Root

1. Remove Root from the shipping carton and examine it for signs of shipping damage or exposed electronics.
2. Confirm that you have all components for the Root by checking all materials against the packing list:
 - Root
 - AC power cord

Note: Save all packing materials, invoice and bill of lading. These may be required to process a claim with the carrier.

If anything is missing or damaged, contact Masimo's Technical Service Department. See **Return Procedure** on page 117.

Guidelines for Setting Up

Root has a built-in bracket interface that allows it to be mounted on a pole or roll stand.

When setting up Root, follow these guidelines:

- Place on a stable, hard, flat, and dry surface near the patient.
- Maintain a minimum of three (3) centimeters (one [1] inch) of free space around Root.
- Ensure that the back panel speaker is not covered to avoid a muffled alarm sound.
- Charge Root's battery fully before use. See **Initial Battery Charging** on page 23.

Root should not be operated outside the environmental conditions listed in the specifications section. See **Environmental** on page 104.

Power On

The Power Button can be used for Power On, Sleep, and Power Off. To Power On, press the Power Button for two (2) seconds until a single audible tone sounds.

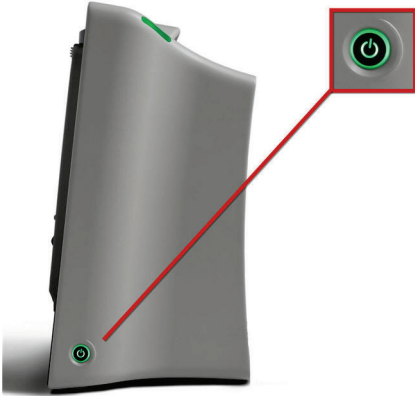

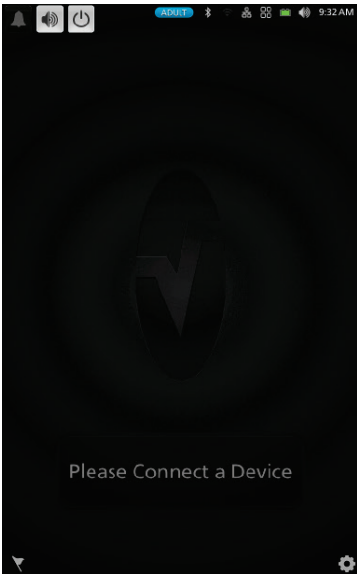

Once Root turns on, if no Radical-7, Radius-7, or MOC-9 module is connected, the Root display shows the following message: *Please Connect a Device*. The user is now able to connect Radical-7, Radius-7, and MOC-9 module.



For information about Sleep Mode and Power Off, see **Sleep and Power Off** on page 73.

Initial Battery Charging

To charge the battery for the first time

1. Securely plug the AC power cord into power entry module.
2. Plug the hospital grade AC power cord into an AC power source.
3. Verify that Root's battery is charging by ensuring that the AC Power Indicator (1) is green and the Battery icon on the Status Bar (2) is solid green or has the charging symbol. See **AC Power Indicator** on page 72 and **About the Status Bar** on page 30.

(1)

(2)
4. The Root Charging Indicator remains orange while the battery is charging and will illuminate green when Root is fully charged. See **Root Battery** on page 55 and **About the Status Bar** on page 30.

See **Safety Information, Warnings, and Cautions** on page 11.

Radical-7 Connection

It is recommended that Root be powered on before performing the steps below.

1. Snap the Radical-7 into the Docking Station.
2. If the Radical-7 is not yet turned on, press the power button on the Radical-7 to power it on.
3. When properly connected, the Radical-7 Charging Indicator light will illuminate. An illuminated Radical-7 Battery icon will also appear in the Status Bar. See **About the Status Bar** on page 30
4. Root display will show active measurements and parameters.



For Radical-7 charging conditions, see **Radical-7 and Radius-7 Charging Indicator** on page 73.

Radius-7 Connection

It is recommended that Root be powered on before performing the steps below.

1. Ensure the Radius-7 Battery Charging Adapter is properly docked in the Docking Station area of Root.
2. Activate the Bluetooth radio on Root. (for more information see Operator's Manual for Radius-7).
3. Place the Radius-7 Battery Module into the charging area of the Radius-7 Battery Charging Adapter.
4. Root will emit a tone when pairing has completed (see Operator's Manual for Radius-7 for more information).
5. When properly connected, an illuminated Radius-7 Battery icon will appear in the Status Bar, and the rainbow Window will appear on the Root display.



MOC-9 Connection

To connect a MOC-9 module to Root

1. Identify the Masimo Open Connect (MOC-9) end of the module.



2. Insert the MOC-9 end of the module securely into a MOC-9 port on Root.



For more information about MOC-9 modules, see **Chapter 8: MOC-9** on page 87.

Nurse Call Connection

Use a Nurse Call connection cable to connect to a Nurse Call System.



To connect to a Nurse Call System

1. Identify the Nurse Call connection end (1/4 inch round female connector) of the cable.
2. Insert the Nurse Call connection cable securely into the compatible port on Root.
3. Depending on the connection type of the Nurse Call System, it may be necessary to orient the other end of the Nurse Call connection cable to fit correctly into the system connection.
4. For more information, see **Device Output** on page 59.

Masimo Kite

Masimo Kite Software Application is a passive monitoring interface to Point-of-Care (POC) Masimo medical devices (Root for example) that co-exist under the same Wi-Fi network. Kite remotely displays system and parameter status reported by the POC device on a separate monitor.

Root must be on the same network as Kite.

Note: If the device is not on the same network, it can be added, but Kite will not be able to connect it to view the parameters monitored by that device until both Kite and the device are connected to the same network.

To add Root to Kite to view parameter status, refer to the Masimo Kite Software Application Operator's Manual.

Bluetooth Devices

External devices can be connected to Root through Bluetooth. For more information about connecting an external device to Root through Bluetooth, see **Chapter 10: Bluetooth Devices** on page 95.

Chapter 3: Operation

The information in this chapter assumes that Root is set up and ready for use. This chapter provides necessary information for proper operation of the device. Do not operate Root without completely reading and understanding these instructions.

About the Main Screen

The Main Screen consists of several features. The following shows the Main Screen when two different devices are connected: Radical-7 (top) showing rainbow® parameters and measurements and SedLine module (bottom) showing brain function measurements.

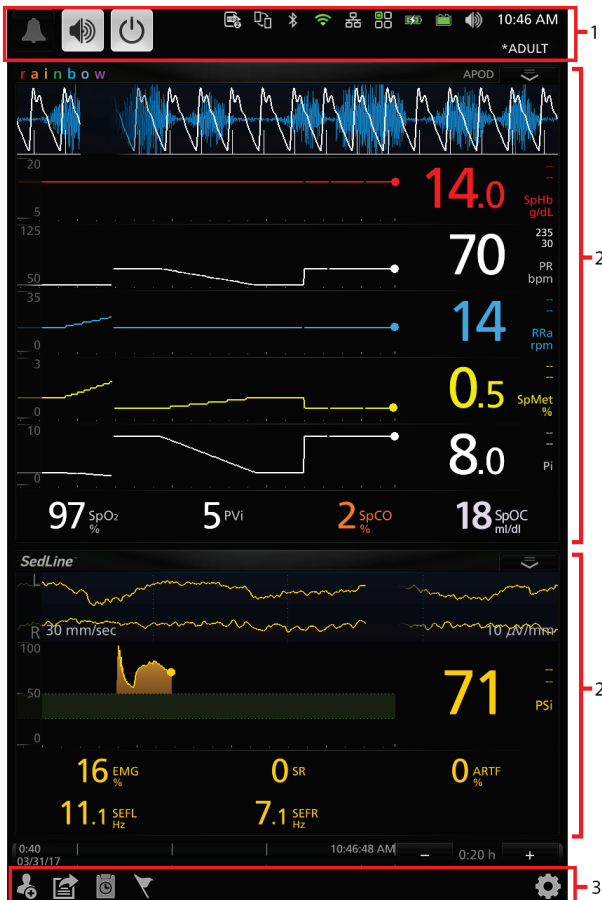

Ref.	Feature	Description
1	Status Bar	Displays system status as well as icons that provide shortcuts to menu items or actions. See About the Status Bar on page 30.
2	Windows	Provides a dynamic, user-configurable display area for all the data from connected medical devices.
3	Action Bar	Provides icons for access to Root options for Patient Admit, EMR Push, Session Management, Manual Events and the Main Menu. See Accessing Main Menu Options on page 46.

About the Status Bar

At the top of the Main Screen is the Status Bar with interactive icons. Each icon provides a shortcut to a menu item or an action on Root. An example is shown below.



Ref.	Feature	Description
1	Alarm Silence	Displays alarm status and temporarily mutes all audible alarms for Root, Radical-7, Radius-7, and MOC-9 modules. See Alarm Silence on page 65.
2	Audio Pause	Displays Audio Pause status and temporarily silences an alarm event. See Audio Pause on page 66.
3	Standby Mode	Allows for patient monitoring to be temporarily suspended. Available when using Root with Radical-7 or Radius-7. See Standby Mode on page 67.

Ref.	Feature	Description
4	Device Output	<p>Provides access to the <i>Device Output</i> screen for activation or deactivation of nurse call functions, USB port output formats, and IntelliBridge connection. If this icon is visible, then USB port 1 and/or USB port 2 are activated.</p> <p>See <i>Device Output</i> on page 59.</p>
5	Kite	<p>Provides access to the <i>Kite</i> screen for activation or deactivation of Kite connection. If this icon is visible, then Kite connectivity has been enabled.</p> <p>See <i>Kite</i> on page 53.</p>
6	Bluetooth	<p>Provides access to the <i>Bluetooth</i> screen. If this icon is visible, then Bluetooth connectivity has been enabled.</p> <p>See <i>Bluetooth</i> on page 55.</p>
7	Wi-Fi	<p>Provides access to the <i>Wi-Fi</i> screen. If this icon is visible, then wireless connectivity has been enabled. The icon also indicates signal strength and Patient SafetyNet connectivity.</p> <p>See <i>Wi-Fi</i> on page 53.</p>
8	Ethernet	<p>Provides access to the <i>Ethernet</i> screen. If this icon is visible, then Ethernet connectivity has been enabled.</p> <p>See <i>Ethernet</i> on page 54.</p>
9	Iris	<p>Provides access to the <i>Iris</i> screen. The example shown above indicates that a standalone device is connected to Port 1 and the information is being sent to Patient SafetyNet or Connectivity Gateway. Ports 2, 3, and 4 are disconnected.</p> <p>The color of the Iris icon matches the status colors of connected standalone devices on the Iris screen. See Chapter 9: Iris on page 89.</p>

Ref.	Feature	Description
10	Radical-7 or Radius-7 Battery	Displays charging status for Radical-7 or Radius-7 and provides access to the <i>Battery Radical-7</i> screen. The example shows that the battery is currently charging. See Radical-7 and Radius-7 Charging Indicator on page 73.
11	Root Battery	Displays charging status for Root and provides access to the <i>Battery Root</i> screen. The example shows that the battery is currently charging. See Root Charging Indicator on page 72.
12	Sounds	Provides access to the <i>Sounds</i> screen to adjust alarm and pulse tone volume. This icon does not indicate the actual volume level of the alarm and pulse tone. See Sounds on page 50.
13	Current Time	Displays the current time and provides access to the <i>Localization</i> screen which contains settings related to local time, language and geography. See Localization on page 52.
14	Profiles	Provides access to the <i>Profiles</i> screen. The example shown illustrates that Profiles is currently set to <i>Adult</i> for an adult patient. See Profiles on page 62.

About the Action Bar

At the bottom of the Main Screen is the Action Bar with interactive icons. Each icon provides a shortcut to a menu item or an action on Root.

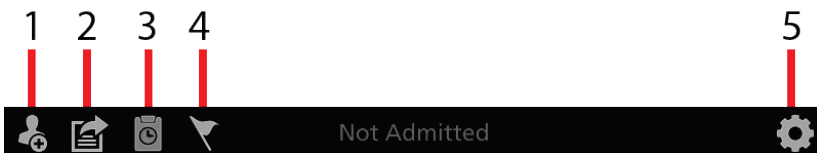







Ref.	Feature	Description
1	Patient Admit/Discharge*	Provides access to admit or discharge a patient. See Admit and Discharge to Patient SafetyNet . on page 75
2	EMR Push*	Provides access to send measured or manually entered patient parameter data. See Electronic Medical Record (EMR) Push on page 81.

Ref.	Feature	Description
3	Session Management	Provides access to Session Management. See Session Management on page 68.
4	Manual Events	Provides access for manual event markers.
5	Main Menu	Provides access to device control options for Root and connected medical devices. See Accessing Main Menu Options on page 46.

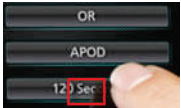
*These icons will only appear when Root is connected to a Patient SafetyNet system v5.0.0.0 or higher or an Iris Gateway system.

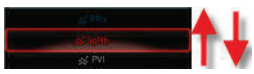
Using the Touchscreen Interface

Use the gestures described below to customize the viewing experience, including displaying the highest priority parameters and measurements. The availability of navigation features is dependent on the connected medical devices.

Action	Illustration	Example	Description
Press			Press and release. Action performed once finger is released.
Slide			Press, move (left, right, up or down), and release. Moves an object across the display.
Swipe			Press, move (left, right, up or down), and release quickly.
Pinch			Press, move, and release two points. Moving points apart zooms in, and moving them together zooms out.

Action	Illustration	Example	Description
Drag and Drop		See <i>Customizing Windows</i> on page 43.	Press, hold, drag an object to desired position, and drop it by releasing.

Below is a list of all the different types of controls available on Root and the various ways to interact with each type of control.

Control	Applicable Actions	Description
Toggle	Slide knob	Switches between toggle states
	Press left or right of toggle	Quickly moves knob left or right
Labeled Toggle	Slide knob	Switches between toggle states
	Press left or right of toggle	Quickly moves knob left or right
	Press label	Quickly moves knob left or right
Spinner	Press center (focused) tile	When closed, expands the spinner When open, collapses the spinner
	Swipe up or down	When open, scrolls through spinner tiles
	Press unfocused tile	When open, scrolls tile into center (focused) position
	Press anywhere outside spinner	When open, collapses spinner
Slider	Slide knob	Moves knob
	Press anywhere along slider path	Quickly moves knob to Tap position
Slider Spinner	Slide knob	Moves knob
	Press anywhere along slider path	Quickly moves knob to Tap position

Control	Applicable Actions	Description
	Press center (focused) tile	When closed, expands the spinner When open, collapses the spinner
	Swipe up/down	When open, scrolls through spinner tiles
	Press unfocused tile	When open, scrolls tile into center (focused) position
	Press anywhere outside spinner	When open, collapses spinner
Button	Press	Performs action (as defined by the button description)
Icon Menu	Press tile	Opens menu specified by tile
	Swipe left or right (anywhere)	Scrolls icons left or right
	Press bottom indicator icon	Quickly centers tile corresponding to indicator icon
Window	Press parameter or measurement	When no parameter or measurement alarm is present, opens parameter or measurement menu When parameter or measurement alarm is present, silences parameter or measurement alarm
	Press and hold	Enables parameter and measurement drag and drop
Well	Press parameter or measurement	When no parameter or measurement alarm is present, opens parameter or measurement menu When parameter or measurement alarm is present, silences parameter or measurement alarm
	Press and hold	Enables parameter and measurement drag and drop
Live Waveform	Swipe down	Separates pleth and acoustic waveforms
	Swipe up	Combines pleth and acoustic waveforms

Control	Applicable Actions	Description
Trend Line	Pinch in	Zooms in
	Pinch out	Zooms out
	Pan	Changes time range
	Press y-axis	Opens parameter or measurement trend menu
Trend Zoom	Press '+'	Increases time range
	Press '-'	Decreases time range
	Press time label	Resets time range to default
Alarm Silence icon	Press	Silences all alarms
Audio Pause icon	Press	Enables Audio Pause
Other Status Bar icons	Press	Opens relevant menu
Back Arrow	Press	Exits menu, abandons any changes

Menu Navigation

When navigating through menus and configuring settings, all changes must be confirmed by selecting **OK**. To cancel the changes, select **Cancel**. Any screen requiring selection of option(s) will time out after one (1) minute of inactivity and return to the Main Screen.



To navigate to the previous screen, press the arrow at the top left corner of the touchscreen.



To return to the *Main* Screen, at any time, press the **Home Button** at any time. The Home Button is always illuminated when Root is powered on.



Understanding Windows

Root creates a Window for Radical-7, Radius-7, and compatible medical devices that are connected to Root. Parameters or measurements can be expanded or minimized within a Window to customize view. Radical-7 Windows are shown in the examples below.

Windows provide waveforms along with either a Trend View or an Analog View. Trend View displays each parameter or measurement alongside a graph of its values over time. Analog View displays values in relation to alarm ranges.

Details about the displayed information of parameters and measurements can be found in the directions for use or Operator's Manual of Radical-7, Radius-7, and MOC-9 modules.

Trend View

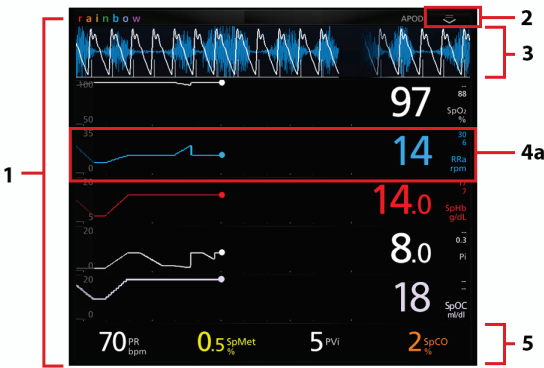

Analog View



Ref.	Feature	Description
1	Window	The area where all data from a docked Radical-7, Radius-7, or connected MOC-9 module are displayed.
2	Action Menu	This menu allows the user to change between Trend View and Analog View. For NIBP and Temperature, the action menu allows access to additional settings. Sensitivity settings can also be selected through the action menu.
3	Waveform	Shows a parameter or measurement over time (only for Radical-7, Radius-7, and MOC-9 modules).
4a	Trend Display	(Available only in Trend View) Parameters and measurements are shown as Trend Displays in Trend View. A parameter or measurement's Trend Display includes its Value Range, Numeric Value, Alarm Limits and Parameter label. See Using Trend View on page 40.
4b	Analog Gauge	(Available only in Analog View) Parameters and measurements are shown as Analog Gauges in Analog View. A parameter's Analog Gauge includes its Alarm Limits, Numeric Value, Parameter Label, as well as Alarming, Caution and Normal Ranges. See Using Analog View on page 41.
5	Well	Displays parameters and measurements which are not shown as Trend Displays or Analog Gauges.

Using Trend View

In Trend View, a parameter or measurement is displayed as a graph of its values over time.

The following diagram and table describe key features of a parameter's Trend Display in Trend View.

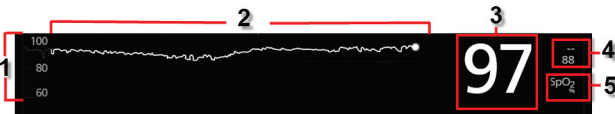

Ref.	Feature	Description
1	Value Range	Indicates current viewing of the parameter or measurement. Press to access the Trend menu where the minimum and maximum of the range can be modified.
2	Trend Graph	Displays parameter and measurement over a period of time. Zoom in and out of a Trend Graph by pinching out and in.
3	Numeric Value	Indicates current reading of the parameter or measurement.
4	Alarm Limits	Indicate high and low alarm limits for the parameter or measurement, if supported.
5	Parameter or Measurement Label	Indicates the name of the parameter or measurement.

Using Analog View

The Analog View shows parameter and measurement data as a needle pointing to graduations in a circular array around a dial. This view provides indications of change that can be interpreted at a quick glance.

Analog View displays alarming and normal ranges of a parameter or measurement. These indicators can be used to alert clinicians to a patient's condition. To understand specific parameters or measurements, refer to the directions for use or operator's manuals for Radical-7, Radius-7, and the appropriate MOC-9 module(s).

The following diagrams and tables describe key features of a parameter's Gauge in Analog View.

When alarm limits for a specific parameter or measurement are set, the corresponding Analog gauge re-oriens itself.

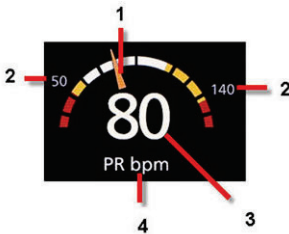

General features of the Analog View are:

Ref.	Feature	Description
1	Needle	Indicates current status of a parameter or measurement.
2	Alarm Limits	Indicate high and low alarm limits for the parameter or measurement.
3	Numeric Value	Indicates current reading of the parameter or measurement.
4	Parameter or Measurement Label	Indicates the name of the parameter or measurement.



Specific ranges of the Analog View are:

Ref.	Feature	Color	Description
1	Normal Range	White	Area of the display range where an alarm will not be triggered.
2	Caution Range	Yellow	Area of the display range that provides a caution indicator.
3	Alarming Range	Red	Area of the display range where an alarm will be triggered.

Some ranges display as quarter circles, others display as half circles. A quarter circle displays when the value has a physiologic normal level at one end of the range. A half circle displays when the value has a physiologic normal level in the middle of the display range.

In the example below, the SpO₂ gauge is shown as a quarter circle, where values lower than 88% will trigger an alarm, and the PR gauge is shown as a half circle, where values below 50 bpm and above 140 bpm will trigger an alarm.



Quarter Circle



Half Circle

Customizing Windows

Windows can be customized by expanding and minimizing parameters and measurements in both Trend View and Analog View. When a parameter is minimized, it is only displayed in the Well with its Numeric Value and Parameter Label. When a parameter is expanded, it will be shown as either a Trend Display or Gauge.

To expand a parameter or measurement

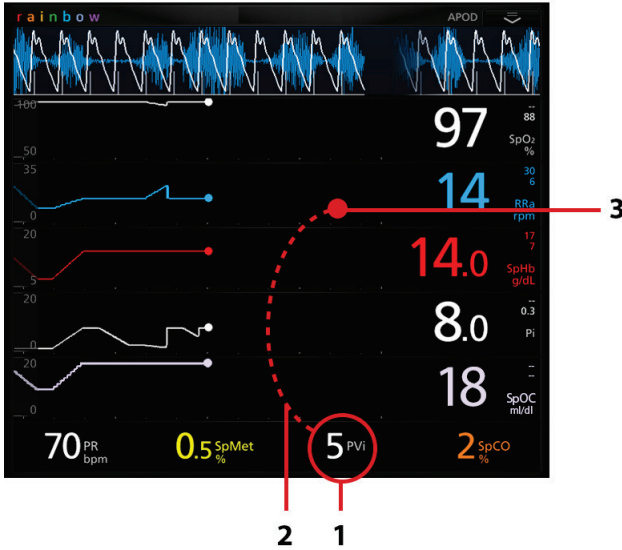

Order	Instruction
Step 1	Press and hold the Numeric Value until it dims.
Step 2	Drag the Numeric Value over any Trend Display.
Step 3	Release the Numeric Value.

Minimizing a parameter or measurement

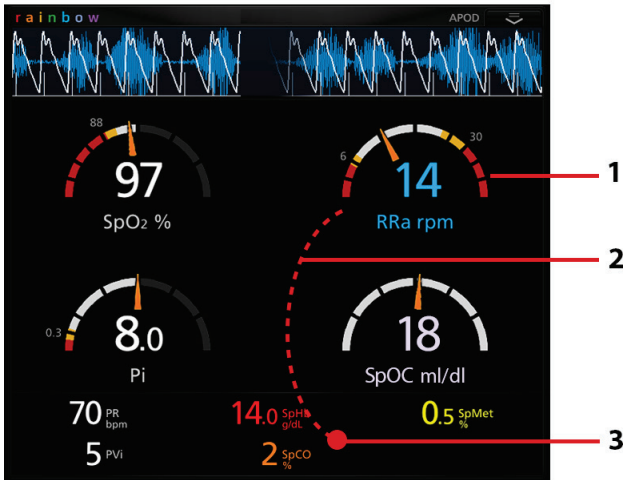

Order	Instruction
Step 1	Press and hold the Numeric Value until it shrinks.
Step 2	Drag the Numeric Value to the Well.
Step 3	Release the Numeric Value.

Manual Sizing of Windows

Expanding and minimizing of windows can be performed from the Main Screen.

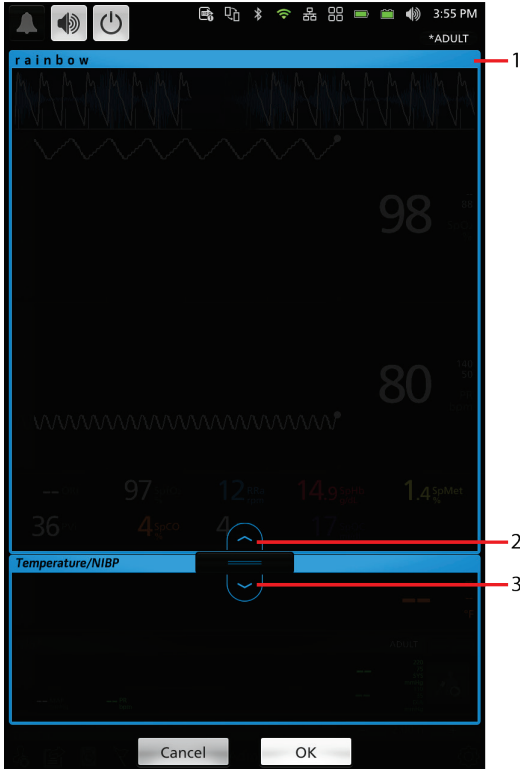

Steps	Instruction
1	Press and hold the header bar of the window to be resized to activate the feature. Window borders turn blue for all windows visible on the main screen.
2	Touch the up arrow to expand the selected window.
3	Touch the down arrow to minimize the selected window.

Note: The selected window can also be resized by touching the bar with an up or down arrow and dragging to resize.

Accessing Main Menu Options

To access the Main Menu options

At the bottom right corner of the touchscreen, press the **Main Menu** icon.



The **Main Menu** options are:



Layout

See *Layout* on page 47.



rainbow

See *Rainbow* on page 50



Sounds

See *Sounds* on page 50.



Device Settings

See *Device Settings* on page 51.



About

See *About* on page 61.



Trend Settings

See *Trend Settings* on page 62.



Profiles

See *Profiles* on page 62.



Iris

See *Chapter 9: Iris* on page 89.

Layout



Use the Layout screen to select sizing options for Windows and Trend Displays.

Available Layouts

When a Radical-7 or Radius-7 is docked to Root and/or multiple MOC-9 modules are connected to Root, the user will have the option to select from several pre-configured layouts. Image below shows layout options available with Radical 7 docked in Root.

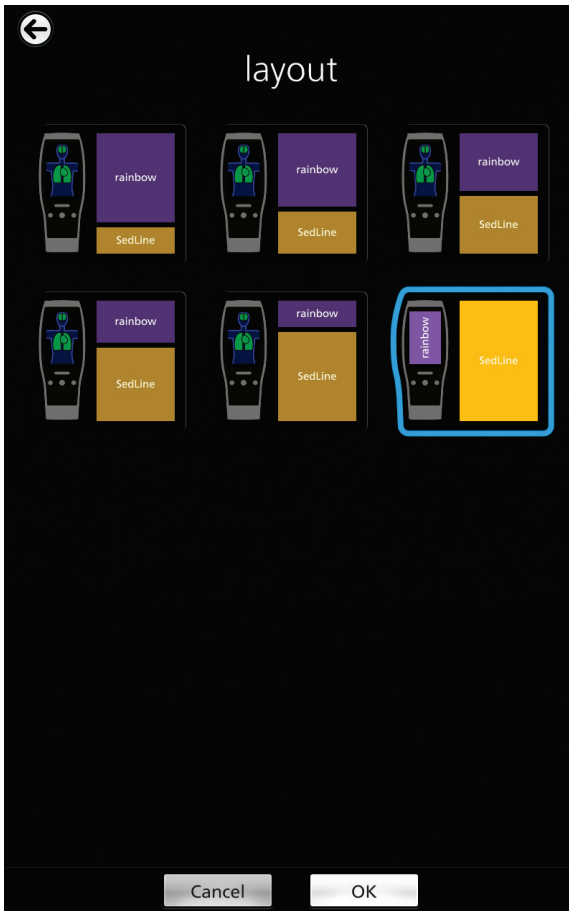

Note: Rainbow window can be viewed on a Radical 7, using software V1.5.3.5 or greater, in several of the pre-configured layouts.

Additional Settings for Layouts



From the **Layout** screen, press **Additional Settings**. Change any of the following options:

Option	Description	Factory Default Settings	User Configurable Settings
Trend Layout	Controls the sizing of Trend Displays.	Dynamic	Fixed or Dynamic
Analog Range	Controls Analog Range Setting.	Fixed	Fixed or Dynamic

The following diagram and tables explain the differences between Fixed and Dynamic modes for a Trend View.

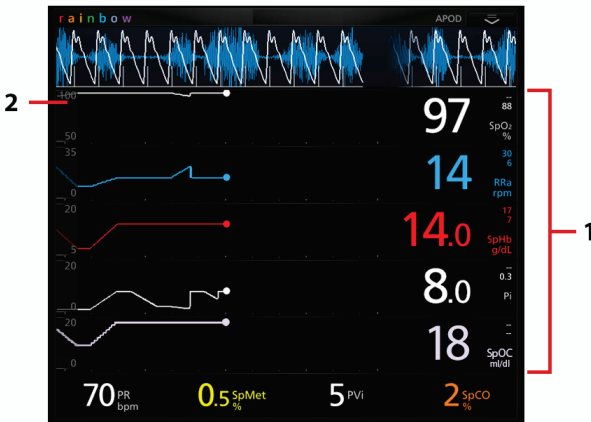

Fixed

Ref.	Description
1	A set number of Trend Displays can be shown at the same time and all Trend Displays are fixed in size. Every additional parameter or measurement expanded will replace an existing Trend Display. For more information about expanding parameters, see Customizing Windows on page 43.

Ref.	Description
2	Size of each Trend Display is fixed.

Dynamic

Ref.	Description
1	Size of all Trend Displays decreases or increases to accommodate parameter(s) expanded or minimized. All Trend Displays are always evenly sized.* For more information about expanding and minimizing parameters, see Customizing Windows on page 43.
2	*Size of each Trend Display is automatically adjusted.

**When the number of Trend Displays reaches maximum viewing capacity, additional parameters expanded will result in the replacement of existing Trend Displays.*

Rainbow



The rainbow icon is displayed only when a Radical-7 or Radius-7 is docked to Root. See Operator manuals for Radical-7 or Radius-7.

Sounds



Use the Sounds screen to control the volume level of sounds and duration of audio pause for Root.

Option	Description	Factory Default Setting	Configurable Settings
Alarm Volume	Sets the alarm volume level.	Highest volume	Slide towards the left to decrease volume to silence.
Pulse Tone Volume	Sets the pulse tone volume level.	3	Slide towards the left to decrease volume to silence.
Audio Pause Duration	Sets the length of time that the audible alarm remains silenced, when Audio Pause is enabled. See Audio Pause on page 66.	2 minutes	1, 2, 3 minutes, Permanent*, Permanent with Reminder*. If <i>Permanent</i> is selected, there will be no audible alarms when Audio Pause is enabled, but visual alarms will still display. If <i>Permanent with Reminder</i> is selected, a tone will sound every three (3) minutes as a reminder that <i>Permanent</i> is active when Audio Pause is enabled.
SmartTone	Allows the audible pulse to continue to beep when the pleth graph shows signs of motion.	Off	On or Off

*Requires the **all mute enabled** option to be toggled to **ON** in the Access Control menu. See **Access Control** on page 57.

Device Settings



The **Device Settings** menu allows the user to view and customize settings for Root.

The **Device Settings** options are:



Localization

See *Localization* on page 52.



Kite

See *Kite* on page 53



Wi-Fi

See *Wi-Fi* on page 53.



Ethernet

See *Ethernet* on page 54.



Bluetooth

See *Bluetooth* on page 55.



Root Battery

See *Root Battery* on page 55.



Radical-7 Battery

See *Radical-7 and Radius-7 Battery* on page 56.



Brightness

See *Brightness* on page 56.



Access Control

See *Access Control* on page 57.



Device Output

See **Device Output** on page 59.

Localization



Use the Localization screen to view the current date and time and configure settings related to local time, language and geography. The user can also access the *Localization* screen by pressing the current time on the Status Bar. See **About the Status Bar** on page 30.

Option	Description	Factory Default Setting	Configurable Settings
Language	Selects the language display for Root.	English	Choose from available languages.
Date Format	Sets the display format for current date.	mm/dd/yy	mm/dd/yy or dd/mm/yy
Time Format	Sets the display format for current time.	12 hour	12 hour or 24 hour
Line Frequency	Sets to match regional power line frequency.	60 Hz	50 Hz or 60 Hz
Date	Sets the current date.	N/A	N/A
Time	Sets the current time.	N/A	N/A

Kite



Use the Kite screen to enable or disable Kite connectivity.

Option	Description	Factory Default Setting	Configurable Settings
Enable Kite Connection	Activates or deactivates an active Kite connection.	Off	On or Off
Pairing Key	Four (4) digit code automatically assigned for active Kite session.	N/A	Automatic with active Kite connection

Wi-Fi



The Wi-Fi radio allows for networked communication of data and alarm signals between Root and a secondary patient monitoring station, Masimo's Patient SafetyNet over an IEEE 802.11 a/b/g wireless network. The wireless data transmission is an optional network data transmission to the wired network data transmission, using Root's integral Ethernet Port.

Root uses only configured MAC addresses to establish wireless communications to prevent unauthorized connections to other wireless devices. As risk mitigation to the loss of the wireless communication, Root's alarm capabilities have been designed to be independent of the Wi-Fi communication feature in order to preserve Root's primary alarms.

Use the Wi-Fi screen to enable or disable Wi-Fi connectivity. When Root is connected to a Wi-Fi network, the Wi-Fi icon on the Status Bar conveys the strength of the connection. See **About the Status Bar** on page 30.

Option	Description	Factory Default Setting	Configurable Settings
Wi-Fi	Enables or disables Wi-Fi connectivity.	Off	On or Off
Additional fields in the <i>Wi-Fi</i> screen display read-only settings about the Wi-Fi connection that cannot be configured by the user.			



Your Masimo sales representative can provide necessary information regarding an initial Wi-Fi connection. For more information, see the Patient SafetyNet Operator's Manual.

CAUTION: Unanticipated failure or alteration of network components (including but not limited to: disconnection or malfunctioning of a networking device/switch/router/ethernet cable) may result in loss of connectivity of Kite to other hospital systems. Altering or making changes to the hospital network should be done with proper knowledge.

Connecting Root to Patient SafetyNet

Root can be configured to connect to Patient SafetyNet wirelessly by authorized and trained personnel only.

The wireless icon in the Status Bar on Root displays the current connection status. See **About the Main Screen** on page 29.

Icon	Description
	A gray icon indicates Root wireless radio is on, but it is not connected to a wireless network.
	A blue icon indicates Root is connected to a wireless network, but not communicating with Patient SafetyNet.
	A green icon indicates Root is connected to a wireless network and communicating directly with Patient SafetyNet.

Ethernet



Use the Ethernet screen to enable or disable Ethernet connectivity. When Ethernet connectivity is enabled, the Ethernet icon will appear in the Status Bar. See **About the Status Bar** on page 30.

Option	Description	Factory Default Setting	Configurable Settings
Ethernet	Enables or disables Ethernet connectivity.	On	On or Off
Additional fields in the Ethernet screen display read-only settings about the Ethernet connectivity that cannot be configured by the user.			

Bluetooth



The Bluetooth radio allows for the detection of the close proximity of Masimo's MyView Presence Tag. Root's detection of Masimo's MyView Presence Tag is an optional feature that allows for the display of predetermined customized settings by a clinician. Root utilizes only configured MAC addresses to establish Bluetooth communication to prevent unauthorized connection to other Bluetooth enabled devices.

Use the Bluetooth screen to enable or disable Bluetooth connectivity. When Bluetooth connectivity is enabled, the Bluetooth icon will appear in the Status Bar. See **About the Status Bar** on page 30.

Option	Description	Factory Default Setting	Configurable Settings
Bluetooth	Enables or disables Bluetooth connectivity.	Off	On or Off

For more information on how to configure MyView Presence Tag, see the Patient SafetyNet Operator's Manual.

Root Battery



Use the Root Battery screen to view the specific percentage of charge on the battery. The user can also access Root's Battery screen by pressing the Battery icon on the Status Bar. See **About the Status Bar** on page 30.

Option	Description
State of Charge	Provides a read-only display of battery level remaining.
Battery Diagnostics	Allows trained personnel to access battery diagnostic information.

Radical-7 and Radius-7 Battery



Use the Battery screen to view the specific percentage of charge on the Radical-7 or Radius-7's battery. For Radical-7, the user can also access the Battery screen by pressing the Battery icon on the Status Bar. See **About the Status Bar** on page 30.

Option	Description
State of Charge	Provides a read-only display of battery level remaining.
Battery Diagnostics	Allows trained personnel to access battery diagnostic information.

Brightness



Use the Brightness screen to adjust the brightness of the Root display.

Option	Description	Factory Default Setting	Configurable Settings
Auto Brightness	Allows automatic adjustment of Root's display brightness based on ambient light.	Off	On or Off
Brightness	Adjust the brightness level of the Root display by sliding the button (4 is brightest).	4	1, 2, 3, 4

Access Control



Access Control contains configurable options and settings that require a password.

To enter Access Control

1. Press the **123** key.

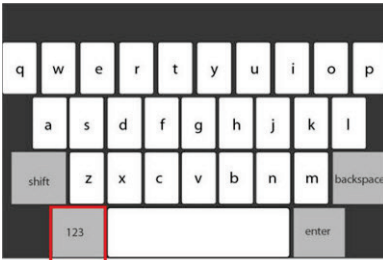

2. When the numeric screen displays, enter the following numbers: **6 2 7 4**
Asterisks (****) will be displayed.
To undo an entry, press **Backspace**.
3. Press **Enter** to access the password protected screen.

Note: The password will have to be entered every time this screen is accessed.

Option	Description	Factory Default Setting	Configurable Settings
Power On Profile	Sets the profile used when the device is powered on.	Previous Profile	Adult, Adult Modified, Neonatal, Pediatric, or Previous Profile
All Mute Enabled	Enables or disables parameter Alarm Silence menu option. See Sounds on page 50.	Off	On or Off
Lock Alarm Volume	Sets the lowest alarm volume level.	Off	3, 4, or Off
Optical Sensor Off Alarm Delay	Enables or disables alarm delay when Optical Sensor is off.	0 Sec.	0, 5, 10, 15, 30, or 60 seconds

Option	Description	Factory Default Setting	Configurable Settings
Standby Enabled	Enables or disables option for Standby Mode. See Standby Mode on page 67.	Off	On or Off
Standby Reminder Tone Interval	Allows for time interval of 30 sec, 1 min, 2 min, 3 min, 5 min, 10 min, or 15 min, as well as Off.	30 sec	30 sec, 1 min, 2 min, 3 min, 5 min, 10 min, 15 min, or Off
Allow Unsigned Upgrade	Allows for Root software to be reverted back to older version	Off	On or Off
Sessions Enabled	Enables or disables Session Management. See Session Management on page 68	Off	On or Off
USB Port 1* baud rate	Enables option to change baud rate of device	921600	9600, 19200, 38400, 57600, 115200, 230400, or 921600
USB Port 2* baud rate	Enables option to change baud rate of device	921600	9600, 19200, 38400, 57600, 115200, 230400, or 921600
Data Collection Enabled	Enables or disables physical data collection mode.	Off	On or Off
EDF Collection Enabled	Enables or disables EDF data collection from SedLine (See Operator's Manual for SedLine)	Off	On or Off
Synchronized Waveforms Enabled	Enables or disables Synchronization Waveform view.	Off	On or Off
Presence Monitoring	Enables or disables Presence Monitoring	Off	On or Off
Save as Adult	Saves current profile parameter as the Adult Profile.	N/A	Press Save to update the profile.

Option	Description	Factory Default Setting	Configurable Settings
Save as Pediatric	Saves current profile parameter as the Pediatric Profile.	N/A	Press Save to update the profile.
Save as Neo	Saves current profile parameter as the Neonatal Profile.	N/A	Press Save to update the profile.
Factory Defaults	Options are restored to factory value.	N/A	Press Restore .

*Changes to USB Ports baud rate will take effect after Root is power cycled, turned off then on again.

Note: Restore Factory Defaults can only be performed during non-monitoring and no cable connections are present.

Device Output



The *Device Output* screen allows the user to configure additional data output options. A Nurse Call can be triggered based on alarm, low Signal IQ events or both. In addition, Nurse Call Polarity can be inverted to accommodate local Nurse Call station requirements.

Option	Description	Factory Default Setting	Configurable Settings
Nurse Call Trigger	Controls the source of monitoring which sets off the trigger.	Alarms	Alarms, Low SIQ, Alarms + SIQ
Nurse Call Polarity	Controls the mechanism of action for triggering to occur. Should be changed to accommodate institutional Nurse Call settings.	Normal	Normal or Inverted
USB Port 1	Controls the output type for USB Port 1.	None	None, SatShare, ASCII 1, IntelliBridge, or IAP

Option	Description	Factory Default Setting	Configurable Settings
USB Port 2	Controls the output type for USB Port 2.	IAP	None, SatShare, ASCII 1, IntelliBridge, or IAP
IntelliBridge Output Options	Controls the data type output for IntelliBridge.	Radical	<ul style="list-style-type: none"> • Radical * • Sedline, O3 Sensor 1/2/L/R* • O3 Sensor 1/2/L/R* • SedLine Numerics only* • Radical Module A*

*Options when IntelliBridge is selected.

Note: The Nurse Call feature is disabled when Audio Pause is enabled and Nurse Call Trigger is set to *Alarms*. For more information about Audio Pause, see **Audio Pause** on page 66.

IntelliBridge Connectivity

IntelliBridge connectivity allows Root to transmit parameters and waveforms to Philips multi-parameter patient monitors that support Philips IntelliBridge device interfacing modules. This option allows parameters and waveforms on Root to be displayed on a Philips monitor and, if applicable, transmitted to the electronic medical record system.

Masimo parameters from SET, rainbow SET, and SedLine, channels are supported.

Masimo waveforms from SET, rainbow SET, channels are supported.

Note: Root supports the transmission of data only. Validations of the retrieval and display of data transmitted is the responsibility of the IntelliBridge manufacturer.

Parameters Supported

IntelliBridge connectivity allows for up to six (6) parameters and two (2) waveforms or eight (8) parameters and no waveform to be displayed on Philips monitors.

Channel	Supported Parameters	Waveforms
SET®	SpO ₂ , PR, Pi, PVi	Pleth
rainbow®	RRa, SpHb, SpCO, SpOC, SpMet	RRa
SedLine®	PSi ⁺ , SR, EMG, ARTF, SEFR, SEFL	N/A
Capnography	etCO ₂ , FiCO ₂ , RR, etN ₂ O, FiN ₂ O, EtO ₂ , FiO ₂ , EtENF, FiENF, EtDES, FiDES, EtHAL, FiHAL, EtISO, FiISO, EtSEV, FiSEV, MAC	CO ₂ uom %, CO ₂ uom kPa, CO ₂ uom mmHg, O ₂ , AAT

About



Use the *About* screen to view the serial number as well as software and hardware version information about Root. These details may be helpful during troubleshooting.

Option	Description
Serial Number	Displays the serial number for the device.
MCU 1	Displays software version number.
Processor	Displays processor version number.
MCU 2	Displays software version number.
MIB	Displays MOC-9 interface revision.

Information about Radical-7, Radius-7, and MOC-9 modules will display in a separate list. These fields are read-only and cannot be configured by the user.

Trend Settings



Use the Trend Settings screen to configure trend viewing on the Main Screen and trend data storage on Root.

Option	Description	Factory Default Setting	Configurable Settings
Default Duration	Duration captured by Trend Graph.	2 hours	15, 30, and 45 minutes 1, 2, 4, 8, 12, 24, 48, 72, and 96 hours
Clear Trends	Delete all stored trend data.	N/A	Press Clear to delete all stored trend data.

To configure trend settings for specific parameters and measurements, see Directions for Use or Operator's Manuals for Radical-7, Radius-7, and appropriate MOC-9 module(s).

Profiles



Use the Profiles screen to select patient type.

Option	Description	Factory Default Setting	Configurable Settings
Profile Name	Identifies the Profiles setting in the device.	Adult	Adult, Pediatric, Neonatal, Custom
Configure Profile	Identifies the patient category type.	Adult	Adult, Pediatric, Neonatal

Root can be configured for various patient types by using the Profiles feature. Profile selection controls the management of patient configuration settings on Root. The settings of the three default profiles (Adult, Pediatric, and Neonatal) configure parameter alarms, averaging time, and sensitivity modes.

Root has the ability to support up to eight (8) custom profiles to accommodate usage in any hospital environment. For more information regarding Profiles, see the Instructions for Use or Operator's Manuals for Radical-7, Radius-7, and appropriate MOC-9 module(s).

Iris





The status of the four (4) Iris Connectivity Ports as well as the connection type (for example, monitor, pump, ventilator) will be displayed on the Iris Status screen. See **Iris Screen** on page 92.

Alarm Interface

Alarms can have different priority levels and come from different sources. The following tables describe alarm behaviors in more detail.

Priority	Alarm Sound
High	10-pulse burst
Medium	3-pulse burst

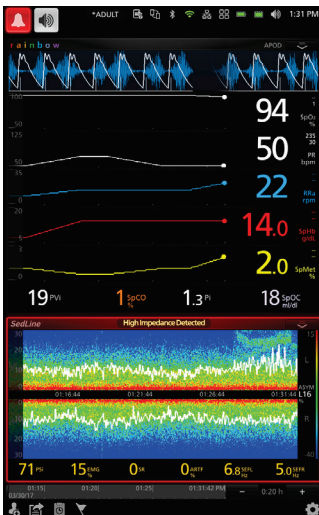
Alarm Source	Example	Explanation
Parameter Level		<p>The example shown here is a PR alarm as the reading (61) exceeds the lower alarm limit (65).</p> <p>Note: The borders of both the PR Trend Display as well as the Window are illuminated red, and the explanation of the alarm is shown at the top of the Window (PR Low < 65).</p>





Alarm Source	Example	Explanation
<p>Window Level</p>		<p>The example shown here is a "High Impedance" alarm in the lower Window.</p> <p>Note: The border of the Window illuminates red, and the explanation of the alarm is shown at the top of the Window (High Impedance Detected).</p>
<p>System Level</p>		<p>The example shown here is a "Low Battery" alarm.</p> <p>Note: The border of the entire Root display is illuminated yellow, and the explanation of the alarm is shown in the Status Bar (Low Battery).</p>

For more details about specific alarms on Radical-7, Radius-7, and MOC-9 modules, see Directions for Use or Operator's Manuals for Radical-7, Radius-7, and MOC-9 modules.

Alarm Silence

The Alarm Silence icon is an indicator as well as a functional button. It always indicates the presence of alarms, and it can be used to temporarily suspend audible alarms for a pre-configured amount of time, known as Silence Duration.

Silence Duration configurations vary across different parameters and measurements. For more information about Silence Duration, refer to the instructions for use or Operator's Manuals for Radical-7, Radius-7, and appropriate MOC-9 module(s).

Icon Appearance	Description	Visual Alarms
	There are currently no active alarms, and no alarms have been silenced.	No
	There are currently no active alarms, but at least one alarm has been and is still silenced.	No
	There is currently at least one active alarm that has not been silenced.	Yes
	There is currently at least one active alarm, but all active alarms are silenced.	Yes

Audio Pause

Audio Pause temporarily suspends all audible alarms on Root. When it is active, visual alarms are not impacted and will still display. The Audio Pause icon is located on the left side of the Status Bar – do not confuse with the Sounds icon on the right side of the Status Bar. See ***About the Status Bar*** on page 30.

By default, Audio Pause is inactive, and the icon appears in the following way:



Audio Pause inactive

To activate Audio Pause, press the icon. It will turn red and the remaining Audio Pause Duration time counts down next to the icon. The default duration for Audio Pause is 120 seconds. In the example below, Audio Pause is activated, and there are 15 seconds left until Audio Pause is inactive again.

To configure Audio Pause, see ***Sounds*** on page 50.



Audio Pause active. 15 seconds until Audio Pause is inactive.

Note: When Audio Pause is activated, powering off and then powering on Root will return Audio Pause to its default inactive state.

Standby Mode

Standby Mode allows for patient monitoring to be temporarily suspended. The Standby icon (see image below) is located in the top-left corner of the screen.

To enable Standby Mode (suspend monitoring)

1. On Root, open the **Access Control** menu.
2. Swipe the **standby enabled** button to **ON**. Return to the home screen on Root, and the Standby icon will appear on the screen in the top-left corner.
3. Press the Standby icon, and a notification message will appear on the screen indicating that monitoring is suspended (see image below).

To exit Standby Mode (resume monitoring)

- Tap anywhere on the screen.

WARNING: When Root is in Standby Mode, monitoring is suspended and no alarms will be active, with the exception of the low battery alarm.

Note: Standby Mode will not affect any devices using Root's Iris Connectivity to Masimo Patient SafetyNet.

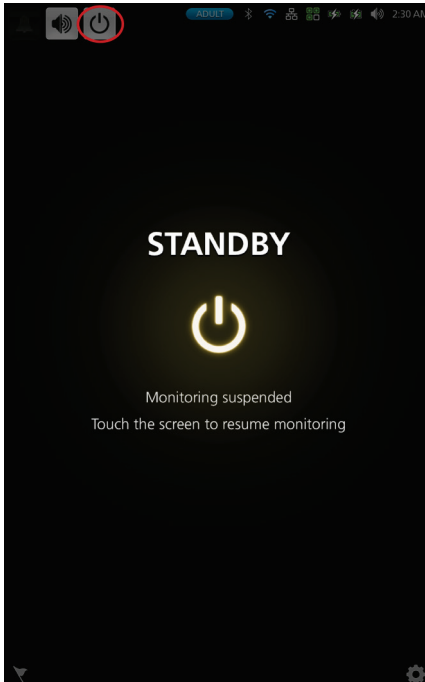

Trend Download

Root can store up to 96 hours of trend data captured at 2-second intervals from Radical-7, Radius-7, and MOC-9 modules. Trend data from Root can be transferred to a computer via USB for evaluation.

Trend data is stored in non-volatile memory, so it is not erased when Root is shut off. Trend data download is initiated using the Masimo Instrument Configuration Tool, which converts the data to a .TXT or .CSV file.

Session Management

Session Management, when enabled, allows clinicians to input a label (session name) which will output with data downloaded from Root.

Enabling Session Management

To enable session management go to Devices Settings. Choose Access Control then slide the Sessions Enabled button to the on position.

Starting Session Management

Press the session management icon  on the Action Bar. Session Name window will open in which you can label the session. When data is downloaded from Root it can be identified by the label assigned to a particular session. See **About the Action Bar** on page 32.

Note: When Session Management is enabled multiple sessions can be recorded, not simultaneously but sequentially.

Ending Session Management

To end a session, go to the Action Bar, press the session management icon with the timer overlay . End Session window will open. Push the End button to end the session.

Note: The maximum time for a session is 96 hours.

Screen Capture

Up to 20 screen capture images can be stored in Root and transferred to a USB drive as PNG files. When the limit of 20 screen captures is reached in Root, every new screen capture will replace the oldest dated screen capture.

Note: There must be a folder titled "screen_shot" in the USB drive with a FAT or FAT32 system file to enable the download of the screenshots.

Capturing Screens

To capture a screen:

Swipe across the Root screen from right to left using three fingers simultaneously (see image below).

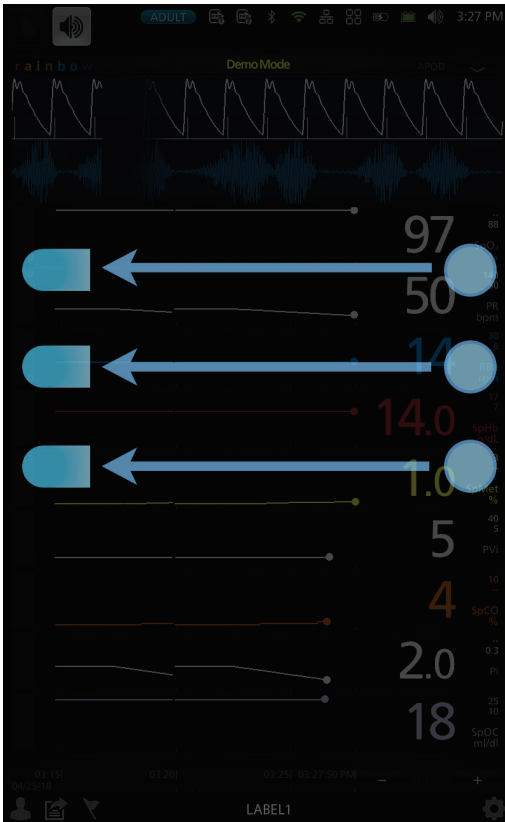

A confirmation flash will appear on the screen indicating a capture is in progress. A status message [1] will be displayed briefly at the top of the screen and the **patient label name will be masked with asterisks** [2].

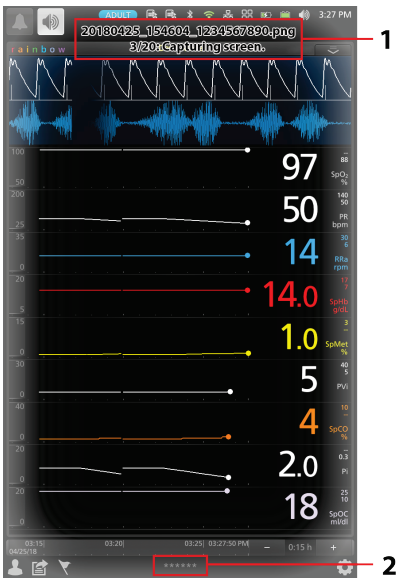

Reference	Example	Description
1	<p style="text-align: center;">Date Time Root Serial Number</p> <div style="border: 1px solid black; padding: 5px; text-align: center; background-color: #333; color: white;"> <p>20180425_154604_1234567890.png 3/20: Capturing screen.</p> </div> <p style="text-align: center;">Number of Screen Captures</p>	<p>The screen capture status message displays the following information:</p> <ul style="list-style-type: none"> • Date: Date of screen capture (YYYYMMDD) • Time: Time of screen capture (HHMMSS) • Device Serial Number: 10 digit Root serial number • Number of Screen Captures: The number of screen captures saved on Root of 20 screen capture limit. When the limit of 20 screen captures is reached, every new screen capture will replace the oldest dated screen capture.
2	<div style="background-color: black; color: white; padding: 2px 10px;">*****</div>	<p>The patient label is masked with asterisks when capturing a screen.</p>

Downloading Screen Captures

To download screen captures:

1. Remove any sensors connected to the patient to stop monitoring, and acknowledge any alarms triggered on Root.
Note: Before connecting the USB drive in the next step, there must be a folder titled "screen_shot" in the USB drive with a FAT or FAT32 system file to enable the download of the screen captures.
2. Plug the USB drive into the USB port located on the rear panel of Root; the screen captures will automatically download. A status message will display briefly at the top of the Root screen to indicate the start of the download.
3. A confirmation status message will display briefly at the top of the Root screen when the file transfer is complete.
4. Unplug the USB drive from Root.

To import the screen captures from the USB drive onto a computer, plug the USB drive into the computers USB port, then open the folder titled "screen_shot" (from the USB drive) on the computer to access the .png files.

Lights

System Status Lights

The System Status Lights provide visual indications of alarms and system messages. The lights will illuminate in different colors depending on the state of the device.

To locate the System Status Lights, see **Side Views** on page 20.

System Status Light

Light Status	Alarm Priority	Indication
None	None	Monitoring has not started.
Green	None	There is currently no active alarms.
Flashing Yellow	Medium	There is an active alarm of medium priority.
Flashing Red	High	There is an active alarm of high priority.

The alarm priority is determined by the Radical-7, Radius-7, and MOC-9 module(s) that are connected to Root. The following are system level alarm messages that accompany System Status Lights when Radical-7, Radius-7, and MOC-9 modules are not connected:

Status Light Message	Alarm Priority
Low battery	Medium
Service required	High

AC Power Indicator



Whenever Root is connected to an AC power source, the AC power indicator illuminates.

Light Status	Indication
Green	Root is connected to an AC power source.
Off	Root is not connected to an AC power source.

Root Charging Indicator



Whenever Root is connected to an AC power source, if not fully charged, its battery will charge.

Light Status	Battery Indication
Green	Battery is fully charged.
Orange	Battery is charging.
Red	Battery charging error.
Off	Battery is not being charged. Root is not connected to AC power source.

Radical-7 and Radius-7 Charging Indicator



When Root is connected to an AC power source, it is able to charge a correctly docked Radical-7 or Radius-7. This is true whether the device is powered on, in Sleep Mode, or powered off. Conversely, when Root is not connected to AC power, it will not charge the device.

The light status provides a visual indication of the battery condition:

Light Status	Battery Indication
Green	Battery is fully charged.
Orange	Battery is charging.
Red	Battery is unable to charge.
Off	Battery is fully charged, not being charged.

Sleep and Power Off

To put Root in the Sleep Mode or Power Off Mode, follow these steps:

State	Description
Sleep Mode	Press and hold the Power Button for two (2) seconds until one (1) audible tone sounds. Sleep Mode conserves power while enabling a quicker startup sequence.
Power Off Mode	Press and hold the Power Button for eight (8) seconds, until two (2) audible tones sound. The Home Button will flash, and the Power Button will flash orange. Power Off Mode completely shuts down Root and results in a longer startup sequence.

Chapter 4: Admit and Discharge to Patient SafetyNet

The Admit/Discharge icon is located at the bottom left of the screen and allows for clinicians to admit or discharge patient's on Masimo Patient SafetyNet directly from Root.

Note: In order to use this feature Masimo Patient SafetyNet software version 5.0.1.0 or higher is required.

Not Admitted

A **Not Admitted** message will appear on the Root screen when the sensor is placed onto a patient and a patient has not yet been admitted on the Root. Press the **Admit** button on the screen to admit the patient or press skip and the patient data will not be transmitted to the Masimo Patient Safety Net.

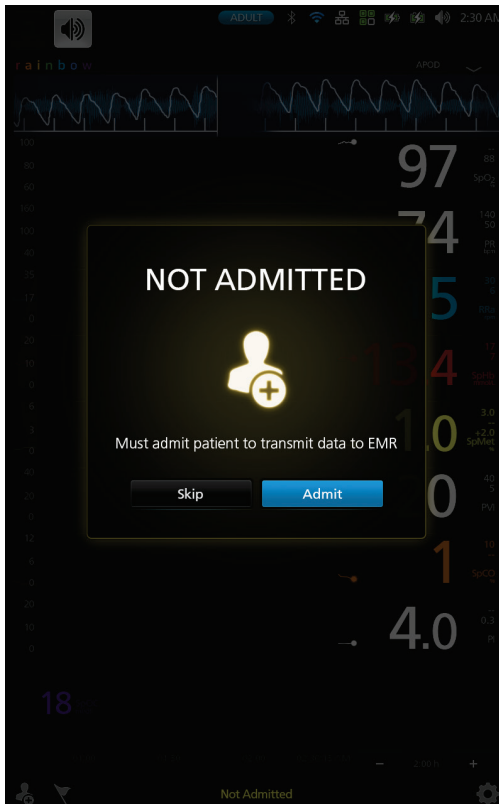

Admitting a Patient

To admit a patient:

1. Press the admit icon  on the bottom-left of the main screen.
2. Enter the authentication PIN.

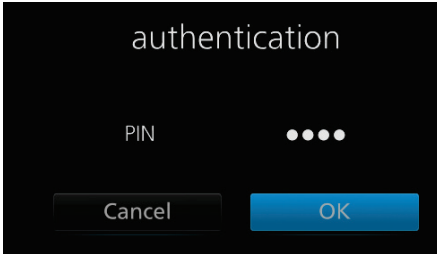

3. Either press the **patient info** search button (1) to select existing patient information, or enter new patient information in the data fields (2).
4. Press the **assignments** search button (3) and select the primary and secondary pagers (4).
5. Press the **Admit** button (5).

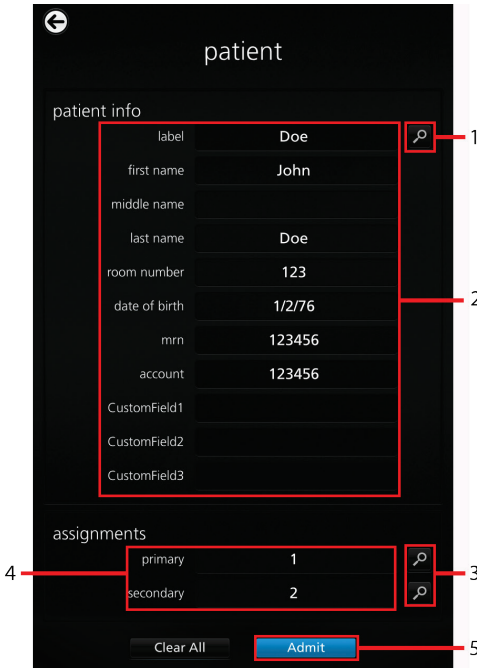

Discharging a Patient

To discharge a patient:

1. Press the discharge icon  on the bottom-left of the main screen.
2. Enter the authentication PIN.

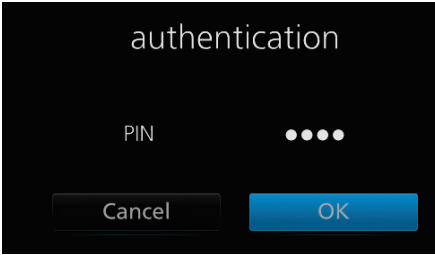

3. Press the **Discharge** button. A confirmation message will appear.

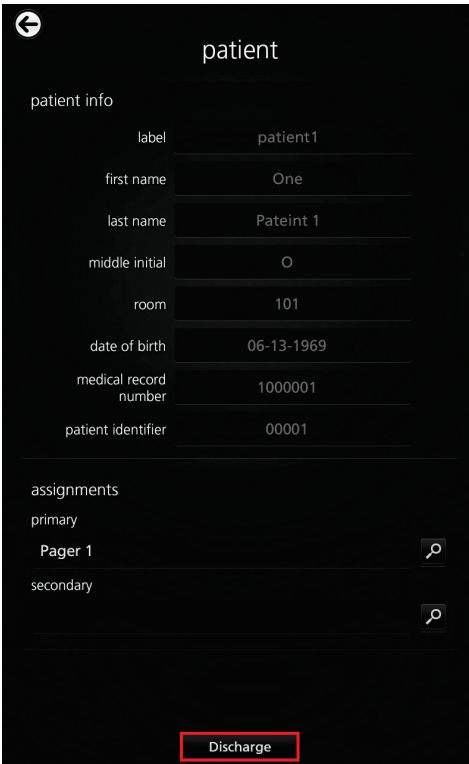

4. Press the **Discharge** confirmation button.

Note: Once patient is discharged from Root, or session is ended, the NIBP parameter display will be cleared.

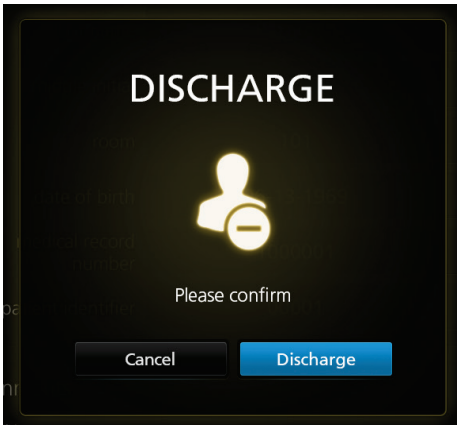

Not Monitoring Message

When the sensor is off the patient for an extended period of time, a **Not Monitoring** message will appear on the screen. Acknowledge the message by pressing **Cancel** or **Discharge**. Press **Discharge** to discharge the patient that is currently admitted on the Root, or press **Cancel** to keep the same patient admitted.

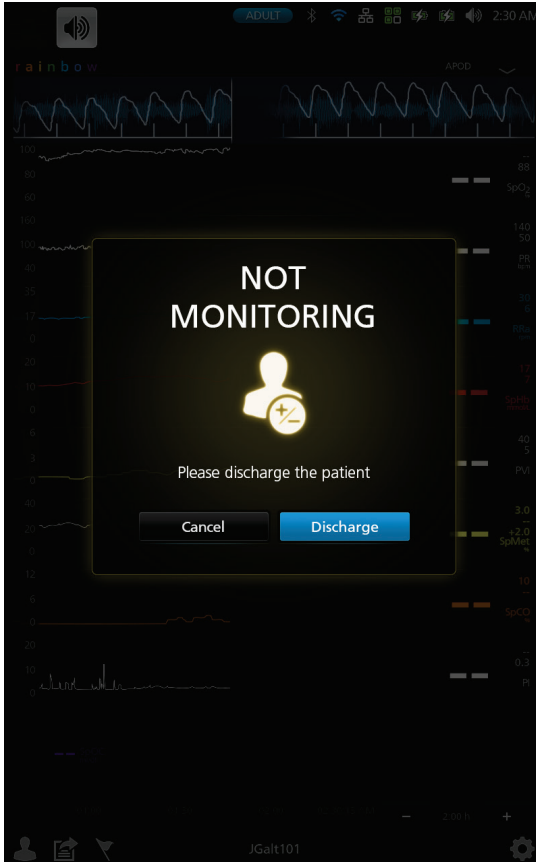

Monitoring Resumed Message

When the sensor is taken off and placed back onto a patient, a **Monitoring Resumed** message will appear on the Root screen.

If this is a new patient, press **Discharge** on the screen to discharge the previous patient. If the same patient is being monitored, press **Confirm** to continue monitoring the same patient.

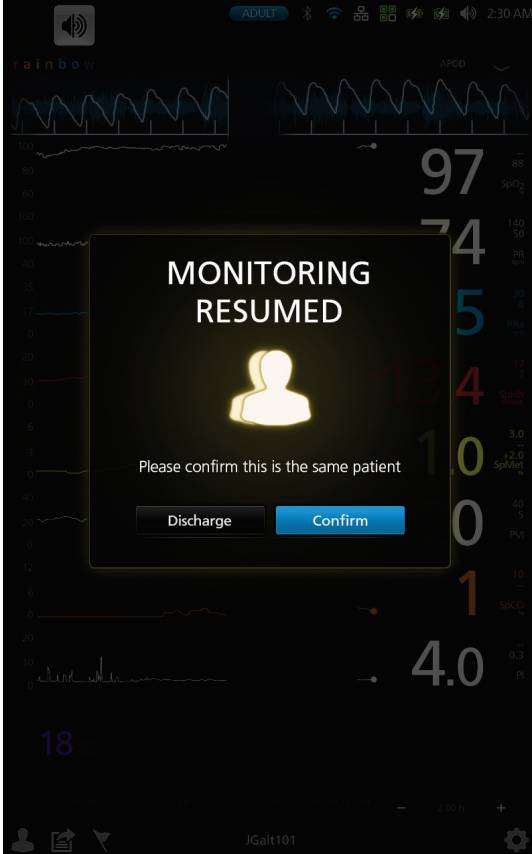

Chapter 5: Electronic Medical Record (EMR) Push

The Electronic Medical Record (EMR) Push feature allows clinicians to send validated patient vital data from any of the Masimo devices, MOC-9 modules, or Iris devices connected to Root directly to a Patient Data Management System, such as an Electronic Medical Record (EMR).

Determining EMR Push is Active

The *EMR Push* icon  appears at the bottom of the Root main screen when the *EMR Push* feature is active. The *EMR Push* feature is active when a Root patient profile is connected to a Patient SafetyNet server. If the *EMR Push* icon does not appear, see **Masimo Technical Services** on page 117.

Note: The Patient SafetyNet server can be configured to require clinicians to provide access credentials to activate the *EMR Push* feature. To configure Patient SafetyNet to require access credentials, see **Masimo Technical Services** on page 117.

Manually Entering Patient Data

Follow the instructions below to manually enter patient data.

Note: Parameters with manual entry permissions can be pre-configured on Patient SafetyNet. See **Masimo Technical Services** on page 117.

1. In the *EMR Push* screen, press a parameter that has a pencil icon .

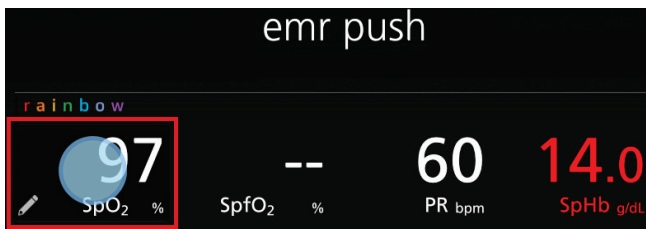

2. In the manual entry screen, move the slide knob or press the spinner to select the desired parameter value.
3. Press **OK** to accept the selected manual entry value, or press **Cancel** to delete the manual entry value and return to the *EMR Push* screen. After pressing **OK**, the selected manual entry value appears on the *EMR Push* screen.

Sending Patient Data to the EMR

Follow the instructions below to send patient data to a data management system using the *EMR Push* feature.

Note: Parameters that appear on the *EMR Push* screen can be pre-configured on Patient SafetyNet. For questions about pre-configuring *EMR Push* parameters, see **Masimo Technical Services** on page 117.

1. Select the *EMR Push* icon  at the bottom of the Root Main Screen.
2. In the *Authentication* screen, enter a username and PIN.
3. Press **OK**.

Note: Username and PIN requirements are enabled through Patient SafetyNet. If unable to authenticate a username and PIN, see **Masimo Technical Services** on page 117.

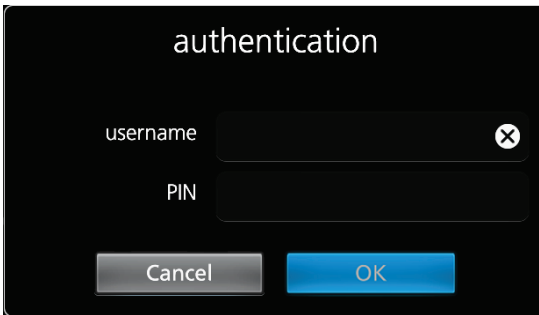

4. In the *EMR Push* screen, review and manually enter patient data before submitting to the EMR. See **Manually Entering Patient Data** on page 81.
5. Press the **Submit** button to send patient data to the EMR or press the **Back** button to return to the Main Screen.
6. After pressing the **Submit** button, select  to send patient data to the EMR.
7. Press **OK** in the *Successfully Sent Data to EMR* confirmation screen.

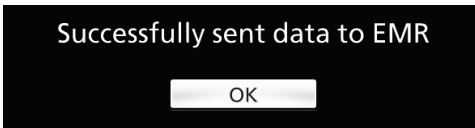

Chapter 6: Radical-7

The Radical-7 is a detachable portable noninvasive monitor that measures arterial oxygen saturation (SpO₂), pulse rate (PR), and perfusion index (Pi), along with optional measurements of hemoglobin (SpHb), carboxyhemoglobin (SpCO), total oxygen content (SpOC), methemoglobin (SpMet), pleth variability index (PVI), and/or acoustic respiration rate (RRa). It can be docked to Root to transfer parameter data to Root. When Radical-7 is docked to Root, the device automatically creates a Window that displays all the data from Radical-7.

Root also acts as a charging station for Radical-7. See Radical-7 Operator's Manual for more information.

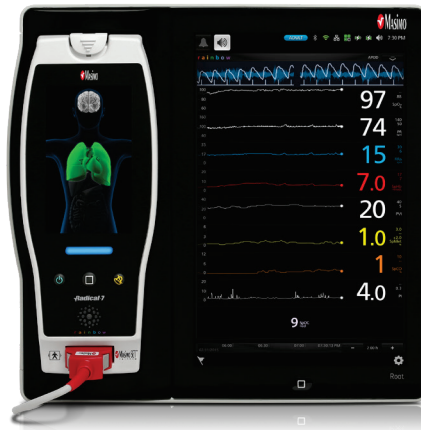

Chapter 7: Radius-7

The Radius-7 is a patient wearable device for continuous monitoring when the patient is ambulatory. It measures arterial oxygen saturation (SpO₂), pulse rate (PR), perfusion index (Pi), and pleth variability index (PVi) along with optional measurements of hemoglobin (SpHb), carboxyhemoglobin (SpCO), total oxygen content (SpOC), methemoglobin (SpMet), and/or acoustic respiration rate (RRa). It uses a Bluetooth connection to transfer parameter data to Root. When Radius-7 is connected to Root via Bluetooth, the device automatically creates a Window that displays all the data from Radius-7.

Root also acts as a charging station for Radius-7. Radius-7 is docked onto Root via a Battery Charging Adapter. See Radius-7 Operator's Manual for more information.



Chapter 8: MOC-9

Flexible measurement expansion is enabled through MOC-9. It can display parameters and measurements captured by SedLine, ISA Capnography, and third-party technologies in an all-in-one view on Root.

When any MOC-9 module is connected, Root automatically creates a Window that displays all the data from that module. The example below shows the "SedLine" and "Capnography" Windows which display data from the SedLine brain function monitoring and ISA capnography MOC-9 modules that are connected to Root. For any MOC-9 device connected to Root, refer to the MOC-9 device's Operator's Manual/Directions for Use for all information.

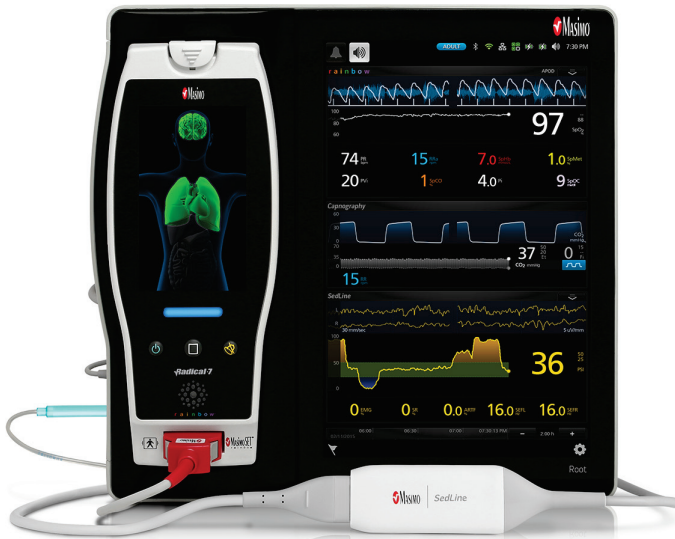

Using MOC-9 Ports

Use a MOC-9 cable to connect other MOC-9 modules to Root.



To use an MOC-9 Port

1. Identify the MOC-9 end of the cable.
2. Orient the cable to fit correctly into an MOC-9 Port.
3. Insert the MOC-9 cable securely into any of the three (3) compatible ports on Root.

Chapter 9: Iris

Iris allows a variety of standalone devices to connect to Root. Patient data can be passed through Root to Patient SafetyNet or Connectivity Gateway, which can send the data to electronic health records.

Below is an example of one way Root can be used in a network setting using Patient SafetyNet. Root receives and may display information from Radical-7, MOC-9 modules, as well as standalone devices.

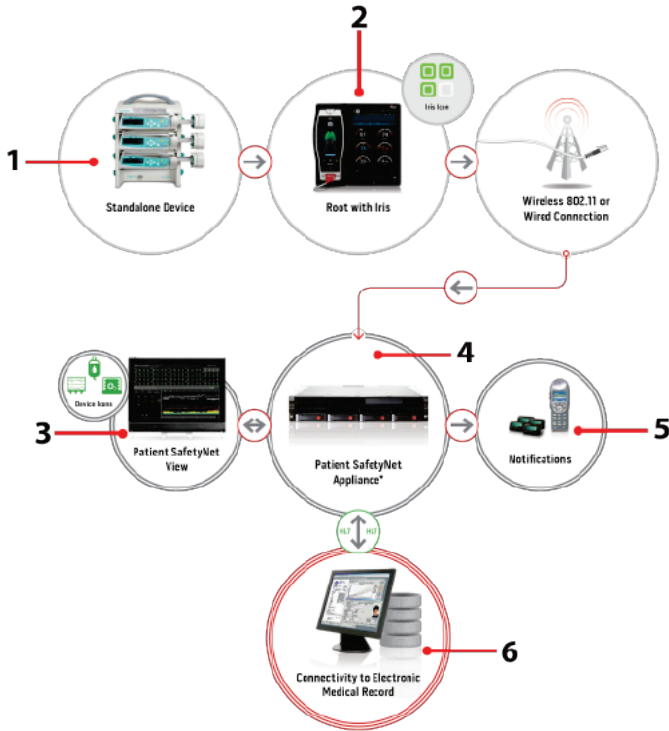

Ref.	Description
1	Standalone devices connected via Iris (e.g., monitor, pump, ventilator)
2	Root
3	Patient SafetyNet View Station
4	Patient SafetyNet or Masimo Connectivity Gateway

Ref.	Description
5	Notification devices
6	Electronic Health Records system

Using Iris Connectivity Ports

Use Iris Adapters and RJ-45 cables to connect standalone devices to Root.

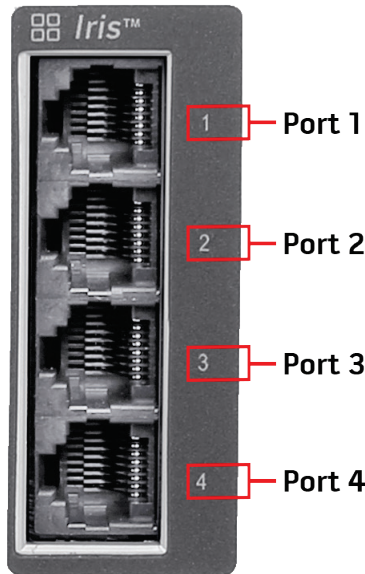

To connect a standalone device via an Iris Connectivity Port:



1. Connect the Iris Adapter to the standalone device. Refer to the Iris Adapter Directions for Use.
2. Connect the RJ-45 end of the Iris Adapter to any of the four (4) compatible Iris Connectivity Ports on Root using a RJ-45 cable.

Iris Icon

The Iris icon located in the *Status Bar* indicates Iris port connectivity status. See ***About the Status Bar*** on page 30. The Iris ports are mapped to the Iris icon according to the diagram below:



Iris connectivity port status is indicated in the Iris icon by color and shape. See the table below for further description.

Iris Port Connection Status	Iris Icon Description	Example	Description of Connection
<i>Connected</i>	Green border with solid green square		Standalone device is successfully connected to Root and Root is successfully connected to a Patient SafetyNet or Connectivity Gateway.
<i>Attempting/Unable to Connect to Server</i>	Yellow border with solid yellow square		Standalone device is connected to Iris adapter in <prod_name_short>, but Root is attempting or unable to connect to a Patient SafetyNet or Connectivity Gateway.
<i>Disconnected</i>	White border		No standalone device is connected to Root and Root is not connected to a Patient SafetyNet or Connectivity Gateway.

Note: Status and connection type are read-only and not configurable by the user. For more information about Iris connectivity, see the Operator's Manual for the appropriate version of Masimo Patient SafetyNet.

Iris Screen

The Iris Screen displays Iris port connectivity and standalone device information.

To view the Iris Screen:

Press the Iris icon in the Status Bar. See **About the Status Bar** on page 30. The Iris Screen displays 4 Iris port connectivity tiles.

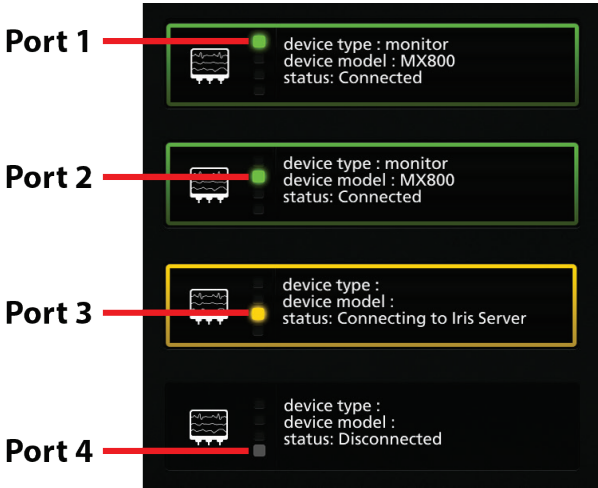

Each Iris port connectivity tile displays the [1] Iris port connectivity indicator and [2] device type, model, and Iris port connectivity status.

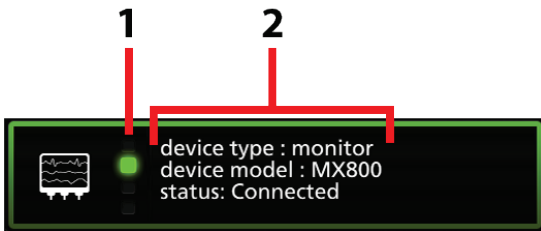

The Iris port connectivity status is indicated by color and displayed message. See the table below for further description.

Connectivity Status Message	Connection Status Color	Description of Connection
<i>Connected</i>	<ul style="list-style-type: none"> Green tile border Green indicator 	Standalone device is successfully connected to Root, and Root is successfully connected to Patient SafetyNet or Iris Gateway.
<i>Connecting to Iris Server</i>	<ul style="list-style-type: none"> Yellow tile border Yellow indicator 	Standalone device is connected to Iris adapter in Root, but Root is attempting or unable to connect to Patient SafetyNet or Iris Gateway.
<i>Disconnected</i>	<ul style="list-style-type: none"> No color tile border Gray indicator 	No standalone device is connected to Root, and Root is not connected to Patient SafetyNet or Iris Gateway.

Note: Status and connection type are read-only and not configurable by the user. For more information about Iris connectivity, see the Operator's Manual for the appropriate version of Masimo Patient SafetyNet.

Chapter 10: Bluetooth Devices

Flexible measurement expansion is possible through the Root Bluetooth connection. Root displays measurements captured by external device technologies in an all-in-one view on Root.

When an external device is connected to Root via Bluetooth, Root automatically creates a window that displays all the data from that device on the *Main Screen*.

Connect Device to Root

Connect an external device to Root using Bluetooth

1. Ensure Bluetooth is enabled on Root. See **Bluetooth** on page 55.
2. Ensure Bluetooth is enabled on the external device; refer to the external device's *Operator's Manual* if needed.
3. On the Root main screen, touch the **Main Menu** icon.
4. Press the **Device Settings** icon.
5. Press the **Bluetooth** icon.
6. On the **Bluetooth** screen:
 - Press the *Pair* button for the desired external device.
 - Select the desired external device under the *Devices Found* list.

The external device is now paired with Root. Refer to the external device's *Operator's Manual* for proper operation.

Chapter 11: Messages

The following messages are specific to Root:

Message	Explanation	Next Step
Battery Charge is Low.	The internal battery needs to be charged. System Status Lights flash yellow.	Charge Root's battery using AC power.
MOC-9 module Disconnected (e.g. SedLine Disconnected)	A MOC-9 module is disconnected from Root.	Reconnect module or acknowledge message by pressing the Alarm Silence icon.
Radical-7 Disconnected	Radical-7 is disconnected from Root.	Reconnect Radical-7 or acknowledge message by pressing the Alarm Silence icon.
Radius-7 Disconnected	Radius-7 is disconnected from Root.	Reconnect Radius-7 or acknowledge message by pressing the Alarm Silence icon.

For additional messages, see Instructions for Use or Operator's Manuals for Radical-7, Radius-7, and MOC-9 modules.

Chapter 12: Troubleshooting

Troubleshooting Radical-7, Radius-7, and MOC-9 Modules

For information on troubleshooting values that are provided from Radical-7, Radius-7, and MOC-9 modules, refer to their respective Instructions for Use or Operator's Manuals.

Troubleshooting Root

Symptom	Possible Cause	Correction
Root does not turn on.	Power Button not pressed long enough.	Press Power Button for two (2) seconds.
	The battery may be depleted.	Connect Root to AC power to charge battery.
	One of the fuses is not operating properly.	Replace the fuse. See Replacing the Fuses on page 115.
Root turns on, but Main Screen is dim or blank.	The brightness setting is not correct.	Adjust the brightness setting. See Brightness on page 56. If the condition persists, Root requires service. Contact Masimo Technical Services. See Return Procedure on page 117.
Touch functionality is not responsive.	Internal failure.	Root requires service. Contact Masimo Technical Services. See Return Procedure on page 117.
Not displaying data from Radical-7, Radius-7, or MOC-9 modules.	Connection error.	Ensure that the connections are securely in place and properly plugged in, or that the cable is not defective. For Radius-7, ensure that the device is paired with Root via Bluetooth. Refer to Operator's Manual of Radius-7 for more information.
Iris screen does not display connection status for standalone devices.	Connection error.	Unplug and replug the Iris Adapter.

Symptom	Possible Cause	Correction
Iris screen does not display connection status for standalone devices.	Connection error.	If the problem persists, refer to instructions for use or operator's manual for the connected standalone devices or Iris section of the instructions for use or operator's manual for the appropriate version of Patient SafetyNet.
Root has a continuous speaker tone.	Internal failure.	To silence an alarm, press the Power Button for eight (8) seconds. If alarm continues to sound, Power Off Root. Root requires service. See Return Procedure on page 117.
Power Button does not respond when pressed.	Power Button may need to be pressed for a longer time.	To Power On when turned off or in Sleep Mode, press Power Button for two (2) seconds. To Power Off when turned on or in Sleep Mode, press the Power Button for eight (8) seconds.
	Internal failure.	Root requires service. See Return Procedure on page 117.
Home Button does not work when pressed.	Internal failure.	Root requires service. See Return Procedure on page 117.
Battery does not charge.	AC power cable may be disconnected.	Unplug and replug AC power cable.
Root Charging Indicator illuminates red.	Internal failure.	Root requires service. See Return Procedure on page 117.
Nurse Call does not communicate.	Connection error.	Unplug and replug Nurse Call connector. See Nurse Call Setting Connections on page 116.
<i>EMR Push</i> icon does not appear in Action Bar.	Wi-Fi is not enabled. Root is not connected to Patient SafetyNet.	Ensure Wi-Fi is enable. See Wi-Fi on page 53. If <i>EMR Push</i> icon does not appear, see Masimo Technical Services on page 117.
Parameter does not appear in <i>EMR Push</i> screen.	Parameter is not configured for <i>EMR Push</i> on Patient SafetyNet.	See Masimo Technical Services on page 117.

Symptom	Possible Cause	Correction
Unable to manually enter parameter data in <i>EMR Push</i> screen.	Parameter is not configured for manual entry on Patient SafetyNet.	See <i>Masimo Technical Services</i> on page 117.

Chapter 13: Specifications

This chapter contains specifications of Root.

For information on the specifications of Radical-7, Radius-7, MOC-9 modules, and standalone devices, see Directions for Use or Operator's Manuals for these devices.

Alarms

Audio Alarm Type	System Status Light Color	Audio Description
High Priority	Flashing Red	10-pulse burst, pulse spacing: 0.250s, 0.250s, 0.500s, 0.250s, repeat time:10s
Medium Priority	Flashing Yellow	3-pulse burst, pulse spacing: 0.375s, 0.375s, repeat time: 7s
Low Priority	Solid Yellow	No audio

Nurse Call Specifications

The Nurse Call relays have the following electrical specifications per switch:

Parameter	Specification
Max Voltage	36 VDC or 24 VAC peak

Connectors

Connector	Type	Number of Ports
Ethernet	10/100 Mbps	1
Nurse Call	1/4 inch round female	1
MOC-9	Masimo Connector	3
USB	USB 2.0	2
Iris	RS-232/RJ-45	4

Electrical

Root	
AC Power requirements	100-240 VAC~, 47-63 Hz, 65VA Max
Fuses (2)	2 Amp, Time Delay High Breaking Capacity (5x20mm), 250V
Battery	
Type	Lithium Ion
Voltage	10.8V (Nominal)
Capacity	4 hours*
Maximum Charging Time	4 hours

*This represents approximate run time at the lowest brightness, using a fully charged battery.

Environmental

Root	
Operating Temperature	32°F to 122°F (0°C to 50°C)
Transport/Storage Temperature	-40°F to 158°F (-40°C to 70°C)
Operating Humidity	10% to 95%, non-condensing
Storage Humidity	10% to 95%, non-condensing
Operating Air Pressure	500 mbar to 1060 mbar -1000 ft to 18,000 ft (-304 m to 5,486 m)

Touchscreen Display

Characteristic	Description
Type	Backlit Active Matrix TFT LCD
Resolution	1280 x 800 pixels
Size	10.1 in (25.65 cm) Diagonal
Color	24 bit RGB
Touchscreen Type	Multi-Touch P-Cap

Wireless Specifications

Communication (Wi-Fi)	
Type	WLAN Radio: IEEE 802.11 a/b/g
Frequency	802.11a: 5180-5240 MHz, 5745-5825 MHz 802.11b/g: 2412-2462 MHz
Max Peak Output Power	WLAN 17 dBm
Classification of Output Power Rating	Conducted
Output Power Type	Fixed at the Factory
Modulation Types	OFDM, BPSK, CCK
Modulation Signals	Analog and Digital
Available Data Rates	802.11a - 6, 9, 12, 18, 24, 36, 48, 54 Mbps. 802.11b - 1, 2, 5.5, 11 Mbps. 802.11g - 6, 9, 12, 18, 24, 36, 48, 54 Mbps.

Communication (Bluetooth)	
Type	Bluetooth
Frequency	2402-2480 MHz
Max Peak Output Power	Bluetooth 1.3 dBm
Classification of Output Power Rating	Conducted
Output Power Type	Fixed at the Factory
Modulation Types	DH5
Modulation Signals	Analog and Digital
Available Data Rates	Bluetooth 1 Mbps
Security and Authentication	
Encryption	64/128-bit WEP, Dynamic WEP, WPA-TKIP, WPA2-AES
Authentication	Open System, Shared Key, Pre-Shared Key (PSK), 802.1X: LEAP, PEAP< TTLS, TLS, EAP-FAST
Radio Compliance	
USA	FCC ID: VKF-RDS7A or VKF-RDS7 Model - RDS-7A or RDS-7
Canada	IC:7362A-RDS7A or 7362A-RDS7 IC Model: RDS-7A or RDS-7 RSS-210
Europe	EN 300 328 EN 301 893 EN 301 489-1 EN 301 489-17 R & TTE Directive

Compliance

Electrical Safety
ANSI/AAMI ES 60601-1:2005
CAN/CSA C22.2 No. 60601-1:2008
EN 60601-1:2006 + A1: 2014
IEC 60601-1:2005 + A1: 2013
IEC 60601-1-8:2006
IEC 60601-2-49:2011
ISO 80601-2-56:2012

EMC Compliance
EN 60601-1-2, Class A

Software Compliance
EN 62304:2006

Equipment Classification per IEC 60601-1	
Type of Protection	Class I (on AC power)
	Internally powered (on battery power)
Degree of Protection of Electrical Shock	Defibrillation proof BF-Applied Part ¹
Protection against harm from liquid ingress	IPX1 Protection against liquid drops falling vertically

Equipment Classification per IEC 60601-1	
Mode of Operation	Continuous Operation

¹Connected devices should be used in accordance with their respective degrees of electrical protection to maintain electrical safety.

Guidance and Manufacturer's Declaration-Electromagnetic Emissions

Guidance and Manufacturer's Declarations - Electromagnetic Emissions		
The ME Equipment is intended for use in the electromagnetic environment specified below. The customer or the user of the ME Equipment should assure that it is used in such an environment.		
Emission Test	Compliance	Electromagnetic Environment - Guidance
RF Emissions CISPR 11	Group 1	ME Equipment uses RF energy only for its internal function. Therefore, its RF emissions are very low and are not likely to cause any interference in nearby electronic equipment.
RF Emissions CISPR 11	Class A	For hospital environment only. Not intended for use in a domestic environment.
Harmonic Emissions IEC 61000-3-2	Class A	
Voltage Fluctuations / Flicker Emissions IEC 61000-3-3	Complies	

Guidance and Manufacturer's Declaration-Electromagnetic Immunity

Guidance and Manufacturer's Declaration - Electromagnetic Immunity			
The ME Equipment is intended for use in the electromagnetic environment specified below. The customer or the user of the ME Equipment should assure that it is used in such an environment.			
Immunity Test	IEC 60601 Test Level	Compliance Level	Electromagnetic Environment - Guidance
Electrostatic discharge (ESD) IEC 61000-4-2	+6 kV contact +8 kV air	+6 kV contact +8 kV air	Floors should be wood, concrete or ceramic tile. If floors are covered with synthetic material, the relative humidity should be at least 30%.
Electrical fast transient/burst IEC 61000-4-4	+2 kV for power supply lines. +1 kV for input/output lines.	---	Mains power quality should be that of a typical commercial or hospital environment.
Surge IEC 61000-4-5	+1 kV - differential mode +2 kV - common mode	---	Mains power quality should be that of a typical hospital environment.
Voltage dips, short interruptions and voltage variations on power supply input lines. IEC 61000-4-11	100% for 0.5 cycle 60% for 5 cycles 30% for 25 cycles 100% for 5 seconds	---	Mains power quality should be that of a typical commercial or hospital environment. Root provides a battery for continued operation during power mains interruption for a maximum of 4 hours.
Power frequency (50 / 60 Hz) magnetic field. IEC 61000-4-8	3 A/m	3 A/m	Power frequency magnetic fields should be at levels characteristic of typical location in a typical hospital environment.

Guidance and Manufacturer's Declaration - Electromagnetic Immunity			
Portable and mobile RF communications equipment should be used no closer to any part of the ME Equipment, including cables, than the recommended separation distance calculated from the equation applicable to the frequency of the transmitter.			
Immunity Test	IEC 60601 Test Level	Compliance Level	Recommended Separation Distance
Conducted RF IEC 61000-4-6	3 Vrms 150 kHz to 80 MHz	3 Vrms	$d = \left[\frac{3,5}{V_1} \right] \sqrt{P}$
Radiated RF IEC 61000-4-3	3 V/m 80 MHz to 2.5 GHz	3 V/m	80 MHz to 800 MHz: $d = \left[\frac{3,5}{E_1} \right] \sqrt{P}$
			800 MHz to 2.5 GHz: $d = \left[\frac{7}{E_1} \right] \sqrt{P}$
---	---	---	<p>where P is the maximum output power rating of the transmitter in watts (W) according to the transmitter manufacturer and d is the recommended separation distance in meters (m).</p> <p>Field strengths from fixed RF transmitters, as determined by an electromagnetic site survey^a, should be less than the compliance level in each frequency range^b.</p> <p>Interference may occur in the vicinity of equipment marked with the following symbol:</p> 
<p>Note 1: At 80 MHz and 800 MHz, the higher frequency range applies.</p> <p>Note 2: These guidelines may not apply in all situations. Electromagnetic propagation is affected by absorption and reflection from structures, objects and people.</p>			

Guidance and Manufacturer's Declaration - Electromagnetic Immunity
<p>(a) Field strengths from fixed transmitters, such as base stations for radio (cellular/cordless) telephones and land mobile radios, amateur radio, AM and FM radio broadcast and TV broadcast cannot be predicted theoretically with accuracy. To assess the electromagnetic environment due to fixed RF transmitters, an electromagnetic site survey should be considered. If the measured field strength in the location in which the ME Equipment is used exceeds the applicable RF compliance level above, the ME Equipment should be observed to verify normal operation. If abnormal performance is observed, additional measures may be necessary, such as re-orienting or relocating the ME Equipment.</p> <p>(b) Over the frequency range 150 kHz to 80 MHz, field strengths should be less than [V1] V/m.</p>

Recommended Separation Distances

Recommended Separation Distance Between Portable and Mobile RF Communication Equipment and the ME Equipment			
<p>The ME Equipment is intended for use in an electromagnetic environment in which radiated RF disturbances are controlled. The customer or the user of the ME Equipment can help prevent electromagnetic interference by maintaining a minimum distance between portable and mobile RF communications equipment (transmitters) and the ME Equipment as recommended below, according to the maximum output power of the communication equipment.</p>			
Rated maximum output power of transmitter (W)	Separation Distance According to Frequency of Transmitter (m)		
	150 K Hz to 80 MHz $d = 1.17 \cdot \sqrt{P}$	80 MHz to 800 MHz $d = 1.17 \cdot \sqrt{P}$	800 MHz to 2.5GHz $d = 2.33 \cdot \sqrt{P}$
0.01	0.12	0.12	0.23
0.1	0.37	0.37	0.74
1	1.17	1.17	2.33
10	3.7	3.7	7.37
100	11.7	11.7	23.3











For transmitters rated at a maximum output power not listed above, the recommended separation distance d in meters (m) can be estimated using the equation applicable to the frequency of the transmitter, where P is the maximum output power rating of the transmitter in watts (W) according to the transmitter manufacturer.























Note 1: At 80 MHz and 800 MHz, the higher frequency range applies.















Note 2: These guidelines may not apply in all situations. Electromagnetic propagation is affected by absorption and reflection from structures, objects and people.

Symbols

The following symbols may appear on the product or product labeling:

Symbol	Description	Symbol	Description
	Follow instructions for use		Consult instructions for use
	Mark of conformity to European medical device directive 93/42/EEC		ETL Intertek certification See Declarations on Page 1 for certifications
IPX1	Protection against vertically falling water drops		Fuse replacement- Only replace with time delay fuses specified in this Instructions for Use
	Non-Sterile		Defibrillation-proof. Type BF applied part
	Separate collection for electrical and electronic equipment (WEEE)		Recyclable
Rx ONLY	Caution: Federal (USA) law restricts this device to sale by or on the order of a physician		Authorized representative in the European community
	Federal Communications Commission (FCC) Licensing	FCC ID:	Identifies unit has been registered as a radio device

Symbol	Description	Symbol	Description
	Non-ionizing electromagnetic radiation	IC Model:	Industry Canada Identification
	Warning, electricity		Biohazardous Waste
	Electrostatic	 SpO ₂	Not for continuous monitoring (No alarm for SpO ₂)
	No parameter alarms	 PVC	Product contains no PVC (polyvinyl chloride) material
	Caution	 LATEX	Not made with natural rubber latex
	Manufacturer	 REF	Catalog number (model number)
	Date of manufacture YYYY-MM-DD	 ####	Masimo reference number
	Storage temperature range	 SN	Serial number
	Keep dry		Fragile, handle with care
	Storage humidity limitation		Do not use if package is damaged
	Atmospheric pressure limitation		Equipotential Ground Terminal
	AC current		Fuse

Symbol	Description	Symbol	Description
	Wireless Symbol level		Wireless features can be used in member states with the restriction of indoor use in France -Class 2 wireless device
	Stand-By		Iris Connection
 RS-232	RS-232 Interface		Ethernet
	Analog Out Interface		Nurse Call Interface
	Greater than		USB port
	Less than		China Restriction of Hazardous Substances
---	---		The names and content of the toxic and hazardous substances or elements shall be provided in the product instruction manual
	Instructions/Directions for Use/Manuals are available in electronic format @ http://www.Masimo.com/TechDocs Note: eIFU is not available for CE mark countries.		

Chapter 14: Service and Maintenance

This chapter contains information about cleaning, battery operation, performance verification, service, repair, and warranty.

Cleaning

Root is a non-sterile and reusable device. The surface of the Root should be cleaned when the device is visibly dirty, before and after each procedure, and/or according to hospital practice.

To surface clean, wipe down the outer surface of Root using any of the following:

- Cidex Plus (3.4% glutaraldehyde)
- 10% bleach solution
- $\leq 70\%$ isopropyl alcohol solution

Do not allow liquids to enter the interior of Root. Using the recommended cleaning solutions on the touchscreen will not affect the performance of Root.

Replacing the Fuses

If a power-related problem causes one or both of the fuses to fail, the fuse(s) will need to be replaced. Replace fuse(s) with UL Listed fuses rated 250V, 2 amp, metric 5x20 mm and with a time delay breaking capacity of minimum 1500A.

WARNING: To ensure safety, only replace with appropriately rated fuses.

The fuses can be removed by hand or with a 5-millimeter or 3/16-inch screwdriver.

To replace the fuse(s)

1. Power Off Root completely. Do not put in Sleep Mode. See ***Sleep and Power Off*** on page 73.
2. Remove the AC power cord from the Power Entry Module in the back panel.
3. Remove the fuse holder by pulling it forward from the Power Entry Module.
4. Remove a fuse by gently pulling the top of the fuse away from the center and then pulling up. The fuse should easily be removed. Do not force.
5. Place a new fuse in the fuse holder.
6. If replacing both fuses, repeat steps 4 and 5 for the second fuse.
7. Slide the fuse holder back into the Power Entry Module and press firmly to make sure it is secure.

Root is ready to be reconnected to AC power. If the fuses fail shortly after replacement, Root requires service. See ***Repair Policy*** on page 116.

Power-On Self Test

To conduct a Power-On Self Test

1. Connect Root to AC power, and verify that the AC Power Indicator is illuminated.

2. Power On Root. Within five (5) seconds, all available indicators will illuminate, the device will emit a tone, and the Masimo logo will display.

Nurse Call Setting Connections

For maximum flexibility, either normally open or normally closed signals are available. During an alarm condition or a low Signal IQ event, depending on the configuration of the device output, the normally open pin will be connected to the common pin and the normally closed pin will be disconnected. In addition, the Nurse Call Polarity can be inverted to accommodate various nurse call station requirements. See **Device Output** on page 59.

Only qualified personnel should connect one of these two signals to a hospital's Nurse Call system.

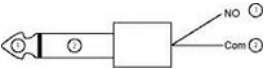
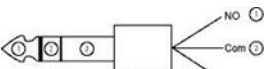
Cable Type	Nurse Call Event	Menu Setting
2-Circuit 	2 contacts normally opened	Nurse Call Polarity Normal
	2 contacts normally closed	Nurse Call Polarity Inverse
3-Circuit 	1 and 2 contacts normally opened 2 and 3 contacts normally closed	Nurse Call Polarity Normal
	1 and 2 contacts normally closed 2 and 3 contacts normally opened	Nurse Call Polarity Inverse

Battery Test

To conduct a Battery Test

1. Fully charge Root by connecting it to AC power.
2. Verify that the Root Charging Indicator is illuminated.
3. When Root is fully charged, the Root Charging Indicator turns off.
4. Power On Root and verify that the Root Battery Indicator icon on the Status Bar shows a full charge.

Repair Policy

Masimo or an authorized Service Department must perform warranty repair and service. Do not use malfunctioning equipment. Have the device repaired.

Clean contaminated and/or dirty equipment before returning, following the cleaning procedure described in **Cleaning** on page 115. Make sure the equipment is fully dry before packing.

To return the device for service, see **Return Procedure** on page 117.

Return Procedure

Clean contaminated/dirty equipment before returning, following instructions in **Cleaning** on page 115. Make sure the equipment is fully dry before packing. Call Masimo at 800-326-4890 and ask for Technical Support. Ask for an RMA number. Package the equipment securely, in the original shipping container if possible, and enclose or include the following information and items:

- A letter describing in detail any difficulties experienced with the Root. Include the RMA number in the letter.
- Warranty information, a copy of the invoice or other applicable documentation must be included.
- Purchase order number to cover repair if the Root is not under warranty, or for tracking purposes if it is.
- Ship-to and bill-to information.
- Person (name, telephone/Telex/fax number, and country) to contact for any questions about the repairs.
- A certificate stating the Root has been decontaminated for bloodborne pathogens.
- Return the Root to the shipping address listed in Contacting Masimo.

Masimo Technical Services

To contact Masimo Technical Services, refer to the Masimo Technical Services web page:

<http://www.masimo.co.uk/company/global-services/technical-services/>

Contacting Masimo

Masimo Corporation
52 Discovery
Irvine, California 92618
Tel:+1 949 297 7000
Fax:+1 949 297 7001

Limited Warranty

Masimo warrants to the original end-user purchaser the Masimo-branded hardware product (Root®) and any software media contained in the original packaging against defects in

material and workmanship when used in accordance with Masimo's user manuals, technical specifications, and other Masimo published guidelines for a period of 12 months and any batteries for six (6) months from the original date the Product was obtained by the end-user purchaser.

Masimo's sole obligation under this warranty is the repair or replacement, at its option, of any defective Product or software media that is covered under the warranty.

To request a replacement under warranty, Purchaser must contact Masimo and obtain a returned goods authorization number so that Masimo can track the Product. If Masimo determines that a Product must be replaced under warranty, it will be replaced and the cost of shipment covered. All other shipping costs must be paid by purchaser.

Exclusions

The warranty does not apply to any non-Masimo branded product or any software, even if packaged with the Product, or any Product that was: (a) not new or in its original packaging when supplied to purchaser; (b) modified without Masimo's written permission; (c) supplies, devices, or systems external to the Product; (d) disassembled, reassembled, or repaired by anyone other than a person authorized by Masimo; (e) used with other products, like new sensors, reprocessed sensors, or other accessories, not intended by Masimo to be used with the Product; (f) not used or maintained as provided in the operator's manual or as otherwise provided in its labeling; (g) reprocessed, reconditioned, or recycled; and (h) damaged by accident, abuse, misuse, liquid contact, fire, earthquake or other external cause.

No warranty applies to any Product provided to Purchaser for which Masimo, or its authorized distributor, is not paid; and these Products are provided AS-IS without warranty.

Limitation of Warranty

Except as otherwise required by law or altered by the purchase agreement, the above warranty is the exclusive warranty that applies to the Product and software media, and Masimo does not make any other promises, conditions, or warranties regarding the Product. No other warranty applies, express or implied, including without limitation, any implied warranty of merchantability, fitness for a particular purpose, satisfactory quality, or as to the use of reasonable skill and care. See the licensing terms for the terms and conditions that apply to and Software accompanying the Product. Additionally, Masimo will not be liable for any incidental, indirect, special, or consequential loss, damage, or expense arising from the use or loss of use of any Products or Software. In no event shall Masimo's liability arising from any Product or Software (under contract, warranty, tort, strict liability, or otherwise) exceed the amount paid by purchaser for the Product or Software. The above limitations do not preclude any liability that cannot legally be disclaimed by contract.

Sales & End-User License Agreement

This document is a legal agreement between you ("purchaser") and Masimo Corporation ("Masimo") for the purchase of this Product ("Product") and a license in the included or embedded Software ("Software") except as otherwise expressly agreed in a separate contract for the acquisition of this Product, the following terms are the entire agreement between the parties regarding your purchase of this Product. If you do not agree to the terms of this

agreement, promptly return the entire Product, including all accessories, in their original packages, with your sales receipt to Masimo for a full refund.

Restrictions

1. **Copyright Restrictions:** The Software and the accompanying written materials are copyrighted. Unauthorized copying of the Software, including Software that has been modified, merged, or included with other software, or the written materials is expressly forbidden. Purchaser may be held legally responsible for any copyright infringement that is caused or incurred by Purchaser's failure to abide by the terms of this Agreement. Nothing in this License provides any rights beyond those provided by 17 U.S.C. §117.
2. **Use Restrictions:** Purchaser may physically transfer the Product from one location to another provided that the Software is not copied. Purchaser may not electronically transfer the Software from the Product to any other device. Purchaser may not disclose, publish, translate, release, distribute copies of, modify, adapt, translate, reverse engineer, decompile, disassemble, or create derivative works based on the Software or the written materials.
3. **Transfer Restrictions:** In no event may Purchaser transfer, assign, rent, lease, sell, or otherwise dispose of the Product or the Software on a temporary basis. Purchaser shall not assign or transfer this License, in whole or in part, by operation of law or otherwise without Masimo's prior written consent; except that the Software and all of Purchaser's rights hereunder shall transfer automatically to any party that legally acquires title to the Product with which this Software is included. Any attempt to assign any rights, duties or obligations arising hereunder other than as set forth in this paragraph shall be void.
4. **U.S. Government Rights:** If Purchaser is acquiring Software (including the related documentation) on behalf of any part of the United State Government, the following provisions apply: the Software and documentation are deemed to be "commercial software" and "commercial computer software documentation," respectively pursuant to DFAR Section 227.7202 FAR 12.212, as applicable. Any use, modification, reproduction, release, performance, display or disclosure of the Software (including the related documentation) by the U.S. Government or any of its agencies shall be governed solely by the terms of this Agreement and shall be prohibited except to the extent expressly permitted by the terms of this Agreement.

Index

A

- About • 46, 61
- About the Action Bar • 32, 68
- About the Main Screen • 29, 54
- About the Status Bar • 23, 24, 30, 52, 53, 54, 55, 56, 66, 91, 92
- About This Manual • 7
- AC Power Indicator • 23, 72
- Access Control • 50, 51, 57
- Accessing Main Menu Options • 30, 33, 46
- Additional Settings for Layouts • 48
- Admitting a Patient • 76
- Alarm Interface • 63
- Alarm Silence • 30, 65
- Alarms • 103
- Audio Pause • 30, 50, 60, 66

B

- Back View • 18
- Battery Test • 116
- Bluetooth • 31, 51, 55, 95
- Bluetooth Devices • 27
- Brightness • 51, 56, 99

C

- Capturing Screens • 69
- Chapter 1
 - Description • 17
- Chapter 10
 - Bluetooth Devices • 27, 95
- Chapter 11
 - Messages • 97
- Chapter 12
 - Troubleshooting • 99
- Chapter 13

- Specifications • 103
- Chapter 14
 - Service and Maintenance • 115
- Chapter 2
 - Setting Up • 21
- Chapter 3
 - Operation • 29
- Chapter 4
 - Admit and Discharge to Patient SafetyNet • 32, 75
- Chapter 5
 - Electronic Medical Record (EMR) Push • 32, 81
- Chapter 6
 - Radical-7 • 83
- Chapter 7
 - Radius-7 • 85
- Chapter 8
 - MOC-9 • 26, 87
- Chapter 9
 - Iris • 31, 46, 89
 - Cleaning • 115, 117
 - Cleaning and Service Warnings and Cautions • 14
 - Compliance • 107
 - Compliance Warnings and Cautions • 14
 - Connect Device to Root • 95
 - Connecting Root to Patient SafetyNet • 54
 - Connectors • 103
 - Contacting Masimo • 117
 - Contraindication • 10
 - Customizing Windows • 34, 43, 48, 49

D

- Determining EMR Push is Active • 81
- Device Output • 26, 31, 52, 59, 116
- Device Settings • 46, 51
- Discharging a Patient • 77
- Downloading Screen Captures • 71

E

- Electrical • 104
- Environmental • 21, 104
- Ethernet • 31, 51, 54
- Exclusions • 118

F

- Features • 17
- Front View • 17

G

- Guidance and Manufacturer's Declaration-Electromagnetic Emissions • 108
- Guidance and Manufacturer's Declaration-Electromagnetic Immunity • 109
- Guidelines for Setting Up • 21

I

- Indications for Use • 9
- Initial Battery Charging • 21, 23
- IntelliBridge Connectivity • 60
- Intended Use • 9
- Iris • 63
- Iris Icon • 91
- Iris Screen • 63, 92

K

- Kite • 14, 31, 51, 53

L

- Layout • 46, 47
- Lights • 71
- Limitation of Warranty • 118
- Limited Warranty • 117
- Localization • 32, 51, 52

M

- Manual Sizing of Windows • 45
- Manually Entering Patient Data • 81, 82
- Masimo Kite • 27
- Masimo Technical Services • 81, 82, 100, 101, 117
- Menu Navigation • 36
- MOC-9 Connection • 25
- Monitoring Resumed Message • 80

N

- Not Admitted • 75
- Not Monitoring Message • 79
- Nurse Call Connection • 26
- Nurse Call Setting Connections • 100, 116
- Nurse Call Specifications • 103

P

- Parameters Supported • 61
- Patient SafetyNet System • 14
- Performance Warnings and Cautions • 12
- Power On • 22
- Power-On Self Test • 115
- Product Description and Features • 9
- Product Description and Features, Intended Use and Indications for Use • 9
- Profiles • 32, 46, 62

R

- Radical-7 and Radius-7 Battery • 51, 56
- Radical-7 and Radius-7 Charging Indicator • 24, 32, 73
- Radical-7 Connection • 24
- Radius-7 Connection • 25
- Rainbow • 46, 50

Recommended Separation Distances • 111
Repair Policy • 115, 116
Replacing the Fuses • 99, 115
Restrictions • 119
Return Procedure • 21, 99, 100, 117
Root Battery • 23, 51, 55
Root Charging Indicator • 32, 72

S

Safety Information, Warnings, and Cautions • 11, 23
Safety Warnings and Cautions • 11
Sales & End-User License Agreement • 118
Screen Capture • 69
Sending Patient Data to the EMR • 82
Session Management • 33, 58, 68
Side Views • 20, 71
Sleep and Power Off • 22, 73, 115
Sounds • 32, 46, 50, 57, 66
Standby Mode • 30, 58, 67
Symbols • 112
System Status Lights • 20, 71

T

Touchscreen Display • 105
Trend Download • 68
Trend Settings • 46, 62
Troubleshooting Radical-7, Radius-7, and MOC-9 Modules • 99
Troubleshooting Root • 99

U

Understanding Windows • 38
Unpacking and Inspection • 21
Using Analog View • 39, 41
Using Iris Connectivity Ports • 90

Using MOC-9 Ports • 87
Using the Touchscreen Interface • 33
Using Trend View • 39, 40

W

Wi-Fi • 31, 51, 53, 100
Wireless Specifications • 105



www.masimo.com

37365/LAB-8425F-1018