

Radical-7™

Radical-7 Operator's Manual



MASIMO®

The Radical-7 operating instructions provide the necessary information for proper operation of all models of the Radical-7 Pulse CO-Oximeter system. There may be information provided in this manual that is not relevant for your system. General knowledge of pulse oximetry and an understanding of the features and functions of the Radical-7 are prerequisites for its proper use. Do not operate the Radical-7 without completely reading and understanding the instructions in this manual.

NOTICE:

Purchase or possession of this instrument does not carry any express or implied license to use this instrument with replacement parts which would, alone or in combination with this instrument, fall within the scope of one of the patents relating to this instrument.



Caution

Federal law restricts this device to sale by or on the order of a physician.

Wireless Radio

FCC ID: VKF-RAD7CA, IC: 7362A-RAD7CA

Masimo Corporation
40 Parker
Irvine, CA 92618, USA
Tel.: 949-297-7000
Fax.: 949-297-7001
www.masimo.com



EU authorized representative for Masimo Corporation:



MDSS GmbH
Schiffgraben 41
D-30175 Hannover, Germany



Medical electrical equipment with respect to electric shock, fire and mechanical hazards only in accordance with UL 60601-1/CAN/CSA C22.2 No. 601.1

Patents: www.masimo.com/patents.htm

© 2012 Masimo Corporation

Adaptive Probe Off Detection[®], APOD[®], Discrete Saturation Transform[®], DST[®], FastSat[®], FST[®], Masimo[®], Pulse Oximeter[®], PVI[®], rainbow[®], SatShare[®], SET[®], Signal Extraction Technology[®], Signal IQ[®], SpCO[®], SpHb[®], SpMet[®] are federally registered trademarks of Masimo Corporation.

Pleth Variability Index™, Radical-7™, Rainbow Acoustic Monitoring™, rainbow Responsible™, RDS™, RRa™, SafetyNet™, SpOC™ are trademarks of Masimo Corporation. All other trademarks and registered trademarks are property of their respective owners. The use of the trademarks PATIENT SAFETYNET and PSN is under license from University HealthSystem Consortium.

Contents

About this Manual	7
Product Description, Indications for Use, Contraindications, and Features	9
Product Description.....	9
Indications for Use.....	10
Contraindications.....	10
Safety Information, Warnings, and Cautions.....	11
Parameter Related Safety Information, Warnings, and Cautions.....	11
Device Related Safety Information, Warnings, and Cautions.....	14
Electrical Safety Information, Warnings, and Cautions	17
Alarm Related Safety Information, Warnings, and Cautions	19
Sensor Related Safety Information, Warnings, and Cautions	20
Chapter 1: Technology Overview	23
Signal Extraction Technology (SET)	23
rainbow Pulse CO-Oximetry Technology	25
rainbow Acoustic Monitoring (RAM) Technology.....	29
Chapter 2: Radical-7 Descriptions	33
General System Description.....	33
Functionality of the Radical-7.....	34
Handheld	35
Standalone	37
Monitor Interface With SatShare.....	40
Chapter 3: Setup.....	41
Unpacking and Inspection	41
Docking Station Power Requirements	41
Setting Up the Docking Station	41
Initial Battery Charging.....	42
Setting Up for Philips, Agilent, or HP VueLink.....	42
Setting Up for SpaceLabs Flexport.....	43
Setting Up and Using SatShare	44
Chapter 4: Operation.....	45
Using the Touchscreen and Buttons.....	45

Radical-7	Contents
Using Screen Lock -----	46
Using the Home Button -----	46
Navigating the Radical-7 -----	47
About the Display View -----	48
Sensitivity Modes Overview -----	55
Changing Sensitivity Modes -----	56
Accessing the Main Menu -----	57
Navigating the Main Menu -----	57
Parameter Settings -----	59
Sounds -----	70
Device Settings -----	71
Trends -----	77
About -----	87
Chapter 5: Profiles -----	89
Profiles Overview -----	89
Changing Profiles -----	90
Replacing Factory Default Settings for Adult and Neo Profiles -----	93
Powering Off the Radical-7 -----	94
Chapter 6: Alarms and Messages -----	95
About Alarms -----	95
Silencing the Alarms -----	95
3D Alarms -----	97
Messages -----	99
Chapter 7: Troubleshooting -----	105
Troubleshooting Measurements -----	105
Troubleshooting the Radical-7 -----	107
Chapter 8: Specifications -----	109
Measurement Range -----	109
Accuracy -----	109
Resolution -----	111
Electrical -----	111
Environmental -----	111
Physical Characteristics -----	112
Trending -----	112

Radical-7	Contents
Alarms-----	112
Display Indicators-----	113
Compliance-----	114
Output Interface-----	115
Wireless Radio (If Installed) -----	115
Serial Interface Specifications-----	115
Serial Interface Setup -----	116
Analog Output and Nurse Call Specifications-----	117
Symbols-----	119
Citations -----	120
Chapter 9: Service and Maintenance-----	123
Cleaning -----	123
Battery Operation and Maintenance -----	123
Performance Verification -----	126
Repair Policy -----	128
Return Procedure-----	128
Contacting Masimo -----	129
Appendix: Best Practices for Comparisons to Reference Measurements-----	131
Best Practices Checklist for Continuous SpHb Comparisons -----	131
Best Practices Checklist for SpCO Comparisons -----	134
Best Practices Checklist for Acoustic Respiration Rate Comparisons-----	136
Index -----	141

About this Manual

This manual explains how to set up and use the Radical-7 Pulse CO-Oximeter. Important safety information relating to general use of the Radical-7 appears in this manual. Read and follow any warnings, cautions, and notes presented throughout this manual. The following are explanations of warnings, cautions, and notes.

A *warning* is given when actions may result in a serious outcome (for example, injury, serious adverse affect, death) to the patient or user. The following is an example of a warning:



Warning

This is a sample of a warning statement.

A *caution* is given when any special care is to be exercised by the patient or user to avoid injury to the patient, damage to this instrument or damage to other property. The following is an example of a caution:



Caution

This is a sample of caution statement.

A *note* is given when additional general information is applicable. The following is an example of a note:

Note: This is a sample of a note.

Product Description, Indications for Use, Contraindications, and Features

The following chapter contains the Radical-7 product description, key features and benefits, indications for use, contraindications, and safety information, including cautions, warnings, and notes.

Product Description

The Radical-7 is a noninvasive monitor that measures arterial oxygen saturation (SpO₂), pulse rate, and perfusion index (PI), along with optional measurements of hemoglobin (SpHb), carboxyhemoglobin (SpCO), methemoglobin (SpMet), total oxygen content (SpOC), Pleth Variability Index (PVI), and Acoustic Respiration Rate (RRa).

The Radical-7 can be used as either a Handheld or a Standalone monitor. The Radical-7 features a touchscreen Liquid Crystal Display (LCD) that continuously displays numeric values for all parameters.

The Radical-7 provides graphical displays for plethysmographic waveform, respiratory waveform, Signal Identification and Quality Indicator (Signal IQ).

The Radical-7 can also be used to interface with a multi-parameter patient monitor to send Masimo SET pulse oximetry information to that monitor for display.

The Radical-7 has an embedded 802.11 wireless radio that can be used for connectivity.

Key Features

The following features are available for the Radical-7. Some features are optional:

- Masimo SET is clinically proven to satisfy all sensitivity and specificity requirements for pulse oximeter technology.
- Rainbow technology uses 7+ wavelengths of light to continuously and noninvasively measure carboxyhemoglobin (SpCO), methemoglobin (SpMet), and total hemoglobin (SpHb), as well as providing a more reliable probe-off detection.
- Total oxygen content (SpOC) provides a calculated measurement of the amount of oxygen in arterial blood, which may provide useful information about oxygen both dissolved in plasma and combined with hemoglobin.
- Perfusion Index (PI) with trending capability indicates arterial pulse signal strength and may be used as a diagnostic tool during low perfusion.
- Pleth Variability Index (PVI) may show changes that reflect physiologic factors such as vascular tone, circulating blood volume, and intrathoracic pressure excursions. [The utility of PVI is unknown at this time and requires further clinical studies. Technical factors that may affect PVI include probe malposition and patient motion.]
- Respiration rate can be determined by the acoustic (RRa) or plethysmographic waveform (RRp).

Radical-7 Product Description, Indications for Use, Contraindications, and Features

- Signal IQ waveform for signal identification and quality indication during excessive motion and low signal to noise situations.
- FastSat tracks rapid changes in arterial O₂.
- Variable pitch provides tonal variance for every 1% change in saturation.
- SatShare interface allows transfer of SpO₂ and pulse rate to an existing multi-parameter monitor and allows for the reading of SpCO, SpMet, SpHb, and SpOC on adjacent Radical-7 monitor.
- Automatic screen rotation provides upright display for vertical or horizontal monitor positioning.
- Multi-gesture touchscreen interface.
- Detachable portable Handheld for patient transport.
- Remote alarm interface.

Indications for Use

The Masimo Radical-7 and accessories are indicated for the continuous noninvasive monitoring of functional oxygen saturation of arterial hemoglobin (SpO₂), pulse rate (PR), carboxyhemoglobin saturation (SpCO), methemoglobin saturation (SpMet), total hemoglobin concentration (SpHb), and/or respiratory rate (RRa).

The Masimo Radical-7 and accessories have been validated and are indicated for use with adult, pediatric, and neonatal patients during both no motion and motion conditions, and for patients who are well or poorly perfused in hospitals, hospital-type facilities, mobile, and home environments.

In addition, the Masimo Radical-7 and accessories are indicated to provide the continuous noninvasive monitoring data obtained from the Masimo rainbow SET Radical 7 Pulse CO-Oximeter and accessories of functional oxygen saturation of arterial hemoglobin (SpO₂) and pulse rate (PR) to multi-parameter devices for the display of those devices.

Contraindications

The Radical-7 is not intended for use as an apnea monitor.

Safety Information, Warnings, and Cautions

The following section lists warnings, caution, notes, and safety information.

The Radical-7 is designed to minimize the possibility of hazards from errors in the software program by following sound Engineering Design Processes, Risk Analysis and Software Validation.

The Radical-7 is to be operated by qualified personnel only. The manual, accessories, directions for use, all precautionary information, and specifications should be read before use.

Always use the Radical-7 precisely in accordance with the directions in this manual, including finger selection, finger alignment in the sensor, and subject behavior during testing. Failure to follow all of the directions in this manual could lead to inaccurate measurements.



Caution

For SpHb, the Radical-7 should be considered an early warning device. Blood samples should be analyzed by laboratory instruments prior to clinical decision making to completely understand the patient's condition.



Caution

Variation in hemoglobin measurements may be profound and may be affected by sample type, body positioning, as well as other physiological conditions. As with most hemoglobin tests, Radical-7 test results should be scrutinized in light of a specific patient's condition. Any results exhibiting inconsistency with the patient's clinical status should be repeated and/or supplemented with additional test data.

Parameter Related Safety Information, Warnings, and Cautions

This section contains parameter related safety information.



Warning

Interfering Substances: Dyes, or any substance containing dyes, that change usual blood pigmentation may cause erroneous readings.



Warning

SpO₂, SpCO, SpMet, and SpHb are empirically calibrated in healthy adult volunteers with normal levels of carboxyhemoglobin (COHb) and methemoglobin (MetHb).

**Warning**

The Radical-7 cannot measure elevated levels of COHb or MetHb.

**Warning**

Inaccurate SpO₂ readings may be caused by:

- Elevated levels of COHb and MetHb
 - For increased COHb: COHb levels above normal tend to increase the level of SpO₂. The level of increase is approximately equal to the amount of COHb that is present.
 - **Note:** High levels of COHb may occur with a seemingly normal SpO₂. When elevated levels of COHb are suspected, laboratory analysis (CO-Oximetry) of a blood sample should be performed.
- For increased MetHb: the SpO₂ may be decreased by levels of MetHb of up to approximately 10% to 15%. At higher levels of MetHb, the SpO₂ may tend to read in the low to mid 80s. When elevated levels of MetHb are suspected, laboratory analysis (CO-Oximetry) of a blood sample should be performed.
- Intravascular dyes such as indocyanine green or methylene blue
- Externally applied coloring and texture such as nail polish, acrylic nails, glitter, etc.
- Elevated levels of bilirubin
- Severe anemia
- Low arterial perfusion
- Motion artifact

**Warning**

Inaccurate SpHb and SpOC readings may be caused by:

- Intravascular dyes such as indocyanine green or methylene blue
- Externally applied coloring and texture such as nail polish, acrylic nails, glitter, etc.
- Elevated levels of bilirubin
- Low arterial perfusion
- Motion artifact
- Low arterial oxygen saturation levels
- Elevated carboxyhemoglobin levels
- Elevated methemoglobin levels
- Difference between patient's finger skin and finger core temperature
- Hemoglobin synthesis disorders
- Hemoglobinopathies and synthesis disorders such as thalassemias, Hb s, Hb c, sickle cell, etc.
- Vasospastic disease such as Raynaud's
- Elevated altitude
- Peripheral vascular disease
- Liver disease
- EMI radiation interference

**Warning**

Inaccurate SpCO and SpMet readings can be caused by:

- Intravascular dyes such as indocyanine green or methylene blue
- Abnormal hemoglobin levels
- Low arterial perfusion
- Low arterial oxygen saturation levels including altitude induced hypoxemia
- Elevated total bilirubin levels
- Motion artifact
- SpCO readings may not be provided if SpO2 readings are less than 90%
- SpCO readings may not be provided if SpMet readings are greater than 2%

Inaccurate SpCO readings can be caused by:

- Levels of methemoglobin approximately 1.5% or above

**Warning**

Inaccurate respiration rate measurements may be caused by:

- Low arterial perfusion
- Motion artifact
- Low arterial oxygen saturation
- Excessive ambient or environmental noise
- Improper sensor placement

**Caution**

If patient hypoxemia is indicated, blood samples should be analyzed by laboratory devices to completely understand the patient's condition.

**Caution**

If the Low Perfusion message is frequently displayed, find a better perfused monitoring site. In the interim, assess the patient and, if indicated, verify oxygenation status through other means.

**Caution**

Changing the SpHb Cal, the date and time of the system clock, or the trend period clears the data in the trend memory.

**Caution**

Excessive ambient noise may affect the accuracy of the respiration rate reading from the Acoustic Respiration Sensor.

When monitoring acoustic respiration, Masimo recommends minimally monitoring both oxygenation (SpO₂) and respiration (RRa).

Device Related Safety Information, Warnings, and Cautions

This section contains device related safety information.

**Warning**

Explosion hazard: Do not use the Radical-7 in the presence of flammable anesthetics or other flammable substance in combination with air, oxygen-enriched environments, or nitrous oxide.

**Warning**

Do not use the Radical-7 or sensor during magnetic resonance imaging (MRI) scanning.

**Warning**

Do not place the Radical-7 or accessories in any position that might cause it to fall on the patient.

**Warning**

During SatShare operation, do not use the plethysmographic waveform display on the multi-parameter monitor for diagnostic purposes. Instead, use the plethysmographic waveform displayed on the Radical-7 screen.

**Warning**

Pulse rate measurement is based on the optical detection of a peripheral flow pulse and therefore may not detect certain arrhythmias. The Radical-7 should not be used as a replacement or substitute for ECG-based arrhythmia analysis.

**Warning**

The Radical-7 can be used during defibrillation, but the readings may be inaccurate for up to 20 seconds.

**Warning**

Do not place containers with liquids on or near the Radical-7. Liquids spilled on the instrument may cause it to perform inaccurately or fail.

**Warning**

EMI radiation interference such as computer displays and/or LCD/plasma TVs can cause error or incorrect measurements on the Radical-7.

**Warning**

If the Radical-7 fails any part of the setup procedures or leakage spot check, remove the instrument from operation until qualified service personnel have corrected the situation.

**Warning**

A functional tester cannot be used to assess the accuracy of the Radical-7.

**Warning**

Do not autoclave, pressure sterilize, or gas sterilize the Radical-7.

**Warning**

Do not touch, press, or rub the display panels with abrasive cleaning compounds, instruments, brushes, rough-surface materials, or bring them into contact with anything that could scratch the panel.

**Warning**

Do not use petroleum-based or acetone solutions, or other harsh solvents, to clean the Radical-7. These substances affect the device's materials and instrument failure can result.

**Warning**

An operator may only perform maintenance procedures specifically described in the manual. Refer servicing to qualified service personnel trained in the repair of this equipment.

**Warning**

SatShare signals are ideal simulated waveforms corresponding to the calculated saturation and pulse rate values and do contain all of the information contained in physiological waveforms. The multi-parameter patient monitor decodes these signals into saturation and pulse rate values.

**Warning**

Simultaneous use of SatShare and serial port is not supported.

**Caution**

Do not place the Radical-7 where the controls can be changed by the patient.

**Caution**

Disposal of product - Comply with local laws in the disposal of the instrument and/or its accessories.

Only SpO₂ and pulse rate can be displayed on the multi-parameter monitor with Flexport.

If the Radical Docking Station is compatible with SafetyNet, Vuelink is not supported.

Use the Radical-7 in accordance with *Environmental Specifications* section in of this manual.

This device complies with part 15 of the FCC Rules. Operation is subject to the following two conditions: (1) This device may not cause harmful interference, and (2) this device must accept any interference received, including interference that may cause undesired operation.

Cleared Use Only: The device and related accessories are cleared by the Food and Drug Administration (FDA) for noninvasive patient monitoring and may not be used for any processes, procedures, experiments or any other use for which the device is not intended or cleared by the FDA, or in any manner inconsistent with the instructions for use or labeling.

Changes or modifications not expressly approved by the party responsible for compliance could void the user's authority to operate the equipment.

In accordance with international telecommunication requirements, the frequency band of 2.4 GHz and 5.15 to 5.25 GHz is only for indoor usage to reduce potential for harmful interference to co-channel mobile satellite systems.

This equipment has been tested and found to comply with the limits for a Class B digital device, pursuant to part 15 of the FCC Rules. These limits are designed to provide reasonable protection against harmful interference in a residential installation. This equipment generates, uses and can radiate radio frequency energy and, if not installed and used in accordance with the instructions, may cause harmful interference to radio communications. However, there is no guarantee that interference will not occur in a particular installation. If this equipment does cause harmful interference to radio or television reception, which can be determined by turning the equipment off and on, the user is encouraged to try to correct the interference by one or more of the following measures:

- Reorient or relocate the receiving antenna.
- Increase the separation between the equipment and receiver.
- Connect the equipment into an outlet on a circuit different from that to which the receiver is connected.
- Consult the dealer or an experienced radio/TV technician for help.

This equipment has been tested and found to comply with the limits for medical devices to the EN 60601-1-2: 2002, Medical Device Directive 93/42/EEC and Class B. These limits are designed to provide reasonable protection against harmful interference in a typical medical installation.

This Class B digital apparatus complies with Canadian ICES-003.

Electrical Safety Information, Warnings, and Cautions

This section contains electrical related safety information.



Warning

Fire Hazard: To protect against fire hazard, replace only with fuses of same type, current rating, and voltage rating.



Caution

Do not place the Radical-7 on electrical equipment that may affect the instrument, preventing it from working properly.



Caution

Dispose of used batteries according to required country or regional instructions.



Caution

Risk of explosion if battery is replaced with an incorrect type. Replace with Masimo supplied parts only.

**Caution**

At Low Battery, connect the Radical-7 to AC power to prevent loss of power.

**Caution**

Do not incinerate battery.

**Caution**

Electric shock hazard: Do not open the Radical-7 cover except to replace the battery or batteries.

**Caution**

To protect against injury from electric shock, follow the directions below:

- Avoid placing the device on surfaces with visible liquid spills.
- Do not soak or immerse the device in liquids.
- Use cleaning solutions sparingly.

**Caution**

Electrical shock and flammability hazard: Before cleaning the Radical-7, always turn it off and disconnect the power cord from the AC power supply.

**Caution**

Do not under any circumstances remove the grounding conductor from the power plug.

**Caution**

Do not use extension cords or adapters of any type. The power cord and plug must be intact and undamaged.

**Caution**

To ensure patient electrical isolation, connect only to other equipment with electrically isolated circuits.

**Caution**

Do not connect to an electrical outlet controlled by a wall switch or dimmer.

All external instrument connections to the Analog Output/Nurse Call connector must be IEC-60950 compliant.

It is recommended that the Radical-7 Handheld is docked to the Docking Station that is attached to an AC power source when it is not in use to ensure that the battery remains fully charged.

External instrument connections to the SatShare port must be IEC-60601-1 compliant.

Only use a SatShare cable that has a ferrite bead installed.

Use the power cord as the means to disconnect the instrument from the main power supply.

If the Radical-7 Handheld has not been used or charged within seven (7) days or more, then recharge the battery prior to use.

The instrument must be configured to match your local power line frequency to allow for the cancelation of noise introduced by fluorescent lights and other sources.

If there is any doubt about the integrity of the protective earth conductor arrangement, operate the Radical-7 on internal battery power until the AC power supply protective conductor is fully functional.

To prevent damage, do not soak or immerse the sensor in any liquid solution. Do not attempt to sterilize by irradiation, steam, autoclave or any method other than ethylene oxide as indicated.

Only SpO2 and pulse rate can be displayed on the multi-parameter monitor with SatShare.

The battery should be installed and/or removed from the Radical-7 by qualified personnel only.

All batteries lose capacity with age, thus the amount of run time at Low Battery will vary depending upon the age of the battery.

All external device connections to the RS-232 serial port must be IEC-60950 compliant.

The Docking Station battery should be installed and/or removed from the Docking Station only by qualified personnel.

To conserve battery power, keep the frequency of the audible alarms to a minimum and the volume to a minimum.

To conserve battery power, keep the back-lit LCD screen at minimum illumination.

When using the SatShare feature, to conserve battery power, always keep the Radical-7 on AC line power.

Alarm Related Safety Information, Warnings, and Cautions

This section contains alarm related safety information.

**Caution**

For home use, ensure that the Radical-7 alarm can be heard from other rooms in the house, especially when noisy appliances such as vacuum cleaners, dishwashers, clothes dryers, televisions, or radios are operating.

**Caution**

Do not place the Radical-7 against a surface that may cause the alarm to be muffled.

**Caution**

To ensure that alarm limits are appropriate for the patient being monitored, check the limits each time the Radical-7 is used.

**Caution**

The Nurse Call feature is disabled when the Audible Alarms are silenced and Nurse Call setting is set to Alarms.

**Caution**

When the Radical-7 is placed in All Mute, the patient alarms will not audibly sound on the Radical-7 or the SafetyNet. The SafetyNet View will display a visual alarm.

**Caution**

During SatShare operation, the audible alarms may be muted on the Radical-7. When the audible alarm is muted (indicated by a bell with a slash through it) on the Radical-7, use the multi-parameter monitor for audible alarm indication.

**Caution**

If an alarm condition occurs while the Alarm Silence period is set to All Mute, the only alarm indications will be visual display and symbols related to alarm condition. No alarm will sound.

The Desat Index alarm is intended as an adjunct rather than in place of the Low Saturation alarm.

Sensor Related Safety Information, Warnings, and Cautions

This section contains sensor related safety information.

**Warning**

As with all medical equipment, carefully route patient cabling to reduce the possibility of patient entanglement or strangulation.

**Warning**

Always remove the sensor from the patient and completely disconnect the patient from the Radical-7 before bathing the patient.

**Caution**

If using the Radical-7 during full body irradiation, keep the sensor out of the radiation field. If the sensor is exposed to the radiation, the reading might be inaccurate or the instrument might read zero for the duration of the active irradiation period.

Do not loop the sensor cable into a tight coil or wrap around the device, as this can damage the sensor cable.

Patient Safety - If a sensor is damaged in any way, discontinue use immediately.

Failure to apply the sensor properly may lead to incorrect measurements.

Additional information specific to the Masimo sensors compatible with Radical-7, including information about parameter/measurement performance during motion and low perfusion, may be found in the sensor's directions for use (DFU).

Do not expose the Masimo sensors used with Radical-7 to moisture, liquids or a humid environment, as this may make the sensor perform inaccurately or fail.

High-intensity extreme lights (including pulsating strobe lights and direct sunlight) directed on the sensor, may not allow the Radical-7 to obtain readings.

When using the Maximum Sensitivity setting, performance of the *Sensor Off* detection may be compromised. If the Radical-7 is in this setting and the sensor becomes dislodged from the patient, the potential for false readings may occur due to environmental "noise" such as light, vibration, and excessive air movement.

Chapter 1: Technology Overview

The following chapter contains general descriptions about parameters, measurements, and the technology used by Masimo products.

Signal Extraction Technology (SET)

Masimo Signal Extraction Technology's signal processing differs from that of conventional pulse oximeters. Conventional pulse oximeters assume that arterial blood is the only blood moving (pulsating) in the measurement site. During patient motion, however, the venous blood also moves, causing conventional pulse oximeters to read low values, because they cannot distinguish between the arterial and venous blood movement (sometimes referred to as noise).

Masimo SET pulse oximetry utilizes parallel engines and adaptive digital filtering. Adaptive filters are powerful because they are able to adapt to the varying physiologic signals and/or noise and separate them by looking at the whole signal and breaking it down to its fundamental components. The Masimo SET signal processing algorithm, Discrete Saturation Transform® (DST®), in parallel with Fast Saturation Transform (FST®), reliably identifies the noise, isolates it and, using adaptive filters, cancels it. It then reports the true arterial oxygen saturation for display on the monitor.

Masimo rainbow SET Parallel Engines

This figure is for conceptual purposes only.

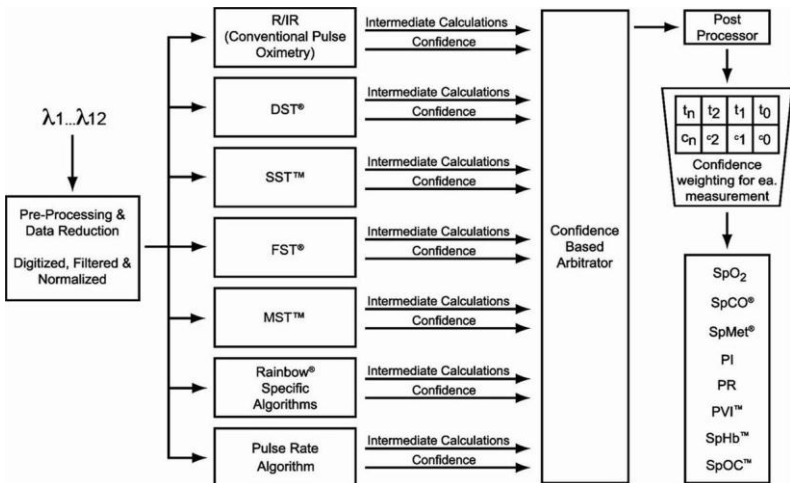

Masimo SET DST

This figure is for conceptual purposes only.

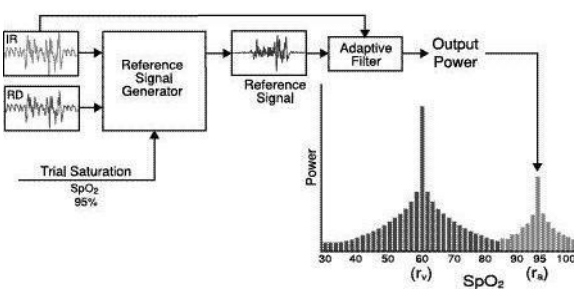

General Description for Oxygen Saturation (SpO₂)

Pulse oximetry is governed by the following principles:

1. Oxyhemoglobin (oxygenated blood) and deoxyhemoglobin (non-oxygenated blood) differ in their absorption of red and infrared light (spectrophotometry).
2. The amount of arterial blood in tissue changes with your pulse (photoplethysmography). Therefore, the amount of light absorbed by the varying quantities of arterial blood changes as well.
3. As a plethysmographic waveform

Successful Monitoring for SpO₂, PR, and PI

Stability of the SpO₂ readings may be a good indicator of signal validity. Although stability is a relative term, experience will provide a good feeling for changes that are artifactual or physiological and the speed, timing, and behavior of each.

The stability of the readings over time is affected by the averaging mode being used. The longer the averaging time, the more stable the readings tend to become. This is due to a dampened response as the signal is averaged over a longer period of time than during shorter averaging times. However, longer averaging times delay the response of the oximeter and reduce the measured variations of SpO₂ and pulse rate.

Functional Oxygen Saturation

The Radical-7 is calibrated to measure and display functional oxygen saturation (SpO₂): the amount of oxyhemoglobin expressed as a percentage of the hemoglobin that is available to transport oxygen.

Note that carboxyhemoglobin is not capable of transporting oxygen, but is recognized as oxygenated hemoglobin by conventional pulse oximetry.

General Description for Pulse Rate (PR)

Pulse rate (PR), measured in beats per minute (BPM) is based on the optical detection of peripheral flow pulse.

General Description for Perfusion Index (PI)

The Perfusion Index (PI) is the ratio of the pulsatile blood flow to the non-pulsatile or static blood in peripheral tissue. PI thus represents a noninvasive measure of peripheral perfusion that can be continuously and noninvasively obtained from a pulse oximeter.

General Description for Pleth Variability Index (PVI)

The pleth variability index (PVI) is a measure of the dynamic changes in the perfusion index (PI) that occur during the respiratory cycle. The calculation is accomplished by measuring changes in PI over a time interval where one or more complete respiratory cycles have occurred. PVI is displayed as a percentage (0-100%).

The utility of PVI is unknown at this time and requires further clinical studies. Technical factors that may affect PVI include probe malposition and patient motion.

rainbow Pulse CO-Oximetry Technology

rainbow Pulse CO-Oximetry technology is governed by the following principles:

1. Oxyhemoglobin (oxygenated blood), deoxyhemoglobin (non-oxygenated blood), carboxyhemoglobin (blood with carbon monoxide content), methemoglobin (blood with oxidized hemoglobin) and blood plasma constituents differ in their absorption of visible and infrared light (using spectrophotometry).
2. The amount of arterial blood in tissue changes with pulse (photoplethysmography). Therefore, the amount of light absorbed by the varying quantities of arterial blood changes as well.

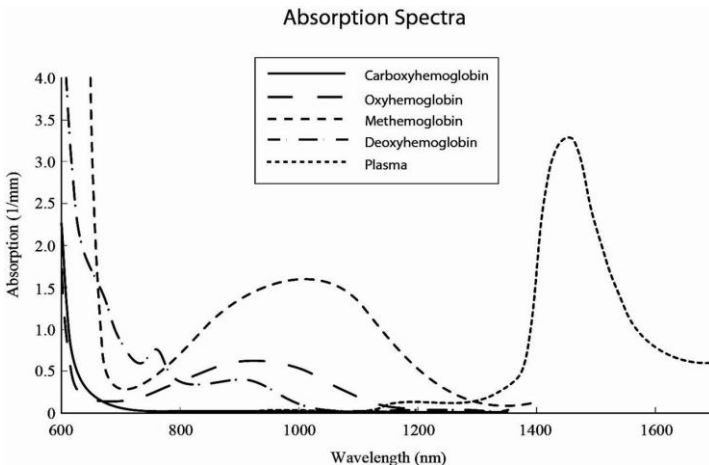

The Radical-7 uses a multi-wavelength sensor to distinguish between oxygenated blood, deoxygenated blood, blood with carbon monoxide, oxidized blood and blood plasma.

The Radical-7 utilizes a sensor with various light-emitting diodes (LEDs) that pass light through the site to a diode (detector). Signal data is obtained by passing various visible and infrared lights (LEDs, 500 to 1400nm) through a capillary bed (for example, a fingertip, a hand, a foot) and measuring changes in light absorption during the blood pulsatile cycle. This information may be useful to clinicians. The maximum radiant power of the strongest light is rated at ≤ 25 mW. The detector receives the light, converts it into an electronic signal and sends it to the Radical-7 for calculation.

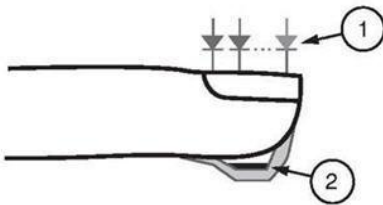

1. Light Emitting Diodes (LEDs)
(7 + wavelengths)
2. Detector

Once the Radical-7 receives the signal from the sensor, it utilizes proprietary algorithms to calculate the patient's functional oxygen saturation (SpO₂ [%]), blood levels of carboxyhemoglobin (SpCO [%]), methemoglobin (SpMet [%]), total hemoglobin concentration (SpHb [g/dL]) and pulse rate (PR). The SpCO, SpMet and SpHb measurements rely on a multi-wavelength calibration equation to quantify the percentage of carbon monoxide and methemoglobin and the concentration of total hemoglobin in arterial blood. In an ambient temperature of 35° C the maximum skin surface temperature has been measured at less than 106° F (41° C), verified by Masimo sensor skin temperature test procedure.

Pulse CO-Oximetry vs. Drawn Whole Blood Measurements

When SpO₂, SpCO, SpMet, and SpHb measurements obtained from the Radical-7 (noninvasive) are compared to drawn whole blood (invasive) measurements by blood gas and/or laboratory CO-Oximetry methods, caution should be taken when evaluating and interpreting the results.

The blood gas and/or laboratory CO-Oximetry measurements may differ from the SpO₂, SpCO, SpMet, SpHb, and SpOC measurements of the Radical-7. Any comparisons should be simultaneous, meaning the measurement on the device should be noted at the exact time that blood is drawn.

In the case of SpO₂, different results are usually obtained from the arterial blood gas sample if the calculated measurement is not appropriately corrected for the effects of variables that shift the relationship between the partial pressure of oxygen (PO₂) and saturation, such as: pH, temperature, the partial pressure of carbon dioxide (PCO₂), 2,3-DPG, and fetal hemoglobin. In the case of SpCO, different results are also expected if concentration of methemoglobin in the blood gas sample is abnormal (greater than 2% for methemoglobin concentration).

High levels of bilirubin may cause erroneous SpO₂, SpMet, SpCO, and SpHb readings. As blood samples are usually taken over a period of 20 seconds (the time it takes to draw the blood) a meaningful comparison can only be achieved if the oxygen saturation, carboxyhemoglobin, and methemoglobin concentration of the patient are stable and not changing over the period of time that the blood gas sample is taken. Subsequently, blood gas and laboratory CO-Oximetry measurements of SpO₂, SpCO, SpMet, SpHb, and SpOC may vary with the rapid administration of fluids and in procedures such as dialysis. Additionally, drawn whole blood testing can be affected by sample handling methods and time elapsed between blood draw and sample testing.

Measurements with Low Signal IQ should not be compared to laboratory measurements.

General Description for Total Hemoglobin (SpHb)

Pulse CO-Oximetry is a continuous and noninvasive method of measuring the levels of total hemoglobin (SpHb) in arterial blood. It relies on the same principles of pulse oximetry to make its SpHb measurement. The measurement is taken by a sensor capable of measuring SpHb, usually on the fingertip for adult and pediatric patients.

The sensor connects directly to the Pulse CO-Oximeter or with a patient cable. The sensor collects signal data from the patient and sends it to the instrument. The instrument displays the calculated data as measurement of total hemoglobin concentration.

Successful Monitoring for SpHb

A stable SpHb reading is associated with correct sensor placement, small physiological changes during the measurement and acceptable levels of arterial perfusion at the measurement site. Physiological changes at the measurement site are mainly caused by fluctuations in the oxygen saturation, blood concentration and perfusion. See **Safety Information, Warnings, and Cautions** on page 11 and **Troubleshooting Measurements** on page 105.

General Description for Total Arterial Oxygen Content (CaO₂)

Oxygen (O₂) is carried in the blood in two forms, either dissolved in plasma or combined with hemoglobin. The amount of oxygen in the arterial blood is termed the oxygen content (CaO₂) and is measured in units of ml O₂/dL blood. One gram of hemoglobin (Hb) can carry 1.34 ml of oxygen, whereas 100 ml of blood plasma may carry approximately 0.3 ml of oxygen*. The oxygen content is determined mathematically as:

$$CaO_2 = 1.34 (ml\ O_2/g\ Hb) \times Hb (g/dL) \times HbO_2 + PaO_2 (mm\ Hg) \times (0.3\ ml\ O_2/100\ mm\ Hg/dL)$$

Where HbO₂ is the fractional arterial oxygen saturation and PaO₂ is the partial pressure of arterial oxygen.

For typical PaO₂ values, the second part of the above equation (PaO₂ [mm Hg] x [0.3 ml O₂/100 mm Hg/dL]) is approximately 0.3 ml/dL. Furthermore, for typical carboxyhemoglobin and methemoglobin levels, the functional saturation (SpO₂) as measured by a pulse oximeter is given by:

$$SpO_2 = 1.02 \times HbO_2$$

*Martin, Laurence. *All You Really Need to Know to Interpret Arterial Blood Gases, Second Edition*. New York: Lippincott Williams & Wilkins, 1999.

General Description for SpOC

The above approximations result in the following reduced equation for oxygen content via the Pulse CO-Oximeter:

$$SpOC (ml/dL^*) = 1.31 (ml\ O_2/g\ Hb) \times SpHb (g/dL) \times SpO_2 + 0.3\ ml/dL$$

*When ml O₂/g Hb is multiplied by g/dL of SpHb, the gram unit in the denominator of ml/g cancels the gram unit in the numerator of g/dL resulting in ml/dL (ml of oxygen in one dL of blood) as the unit of measure for SpOC. See **Safety Information, Warnings, and Cautions** on page 11.

General Description for Carboxyhemoglobin (SpCO)

Pulse CO-Oximetry is a continuous and noninvasive method of measuring the levels of carboxyhemoglobin concentration (SpCO) in arterial blood. It relies on the same basic principles of pulse oximetry (spectrophotometry) to make its SpCO measurement.

The measurement is obtained by placing a sensor on a patient, usually on the fingertip for adults and the hand or foot for infants. The sensor connects either directly to the Pulse CO-Oximetry instrument or through an instrument patient cable.

The sensor collects signal data from the patient and sends it to the instrument. The instrument displays the calculated data as percentage value for the SpCO, which reflect blood levels of carbon monoxide bound to hemoglobin.

Successful Monitoring for SpCO

A stable SpCO reading is associated with correct sensor placement, small physiological changes during the measurement and acceptable levels of arterial perfusion in the patient's

fingertip (measurement site). Physiological changes at the measurement site are mainly caused by fluctuations in the oxygen saturation, blood concentration and perfusion.

General Description for Methemoglobin (SpMet)

Pulse CO-Oximetry is a continuous and noninvasive method of measuring the levels of methemoglobin concentration (SpMet) in arterial blood. It relies on the same basic principles of pulse oximetry (spectrophotometry) to make its SpMet measurement.

The measurement is obtained by placing a sensor on a patient, usually on the fingertip for adults and the hand or foot for infants. The sensor connects either directly to the Pulse CO-Oximetry instrument or through a patient cable.

The sensor collects signal data from the patient and sends it to the instrument. The instrument displays the calculated data as percentage value for the SpMet.

Successful Monitoring for SpMet

A stable SpMet reading is associated with correct sensor placement, small physiological changes during the measurement and acceptable levels of arterial perfusion in the patient's fingertip (measurement site).

Physiological changes at the measurement site are mainly caused by fluctuations in the oxygen saturation, blood concentration and perfusion. See **Safety Information, Warnings, and Cautions** on page 11.

SpCO, SpMet, and SpHb Measurements During Patient Motion

The Radical-7 displays measurements of SpCO, SpMet, and SpHb during patient motion. However, because of the changes in the physiological parameters such as blood volume, arterial-venous coupling, etc. that occur during patient motion, the accuracy of such measurements may not be reliable during excessive motion. In this case, the measurement value for SpCO, SpMet, or SpHb displays as dashes (---) and a message (*Low SpCO SIQ, Low SpMet SIQ, or Low SpHb SIQ*) displays to alert the clinician that the instrument does not have confidence in the value due to poor signal quality caused by excessive motion or other signal interference.

rainbow Acoustic Monitoring (RAM) Technology

rainbow Acoustic Monitoring (RAM) continuously measures a patient's respiration rate based on airflow sounds generated in the upper airway. The Acoustic Sensor translates airflow sounds generated in the upper airway to an electrical signal that can be processed to produce a respiration rate, measured as breaths per minute.

Respiratory sounds include sounds related to respiration such as breath sounds (during inspiration and expiration), adventitious sounds, cough sounds, snoring sounds, sneezing sounds, and sounds from the respiratory muscles [1].

These respiratory sounds often have different characteristics depending on the location of recording [2] and they originate in the large airways where air velocity and air turbulence induce vibration in the airway wall. These vibrations are transmitted, for example, through

the lung tissue, thoracic wall and trachea to the surface where they may be heard with the aid of a stethoscope, a microphone or more sophisticated devices.

rainbow Acoustic Monitoring Architecture

The following figure illustrates how a respiratory sound produced by a patient can be turned into a numerical measurement that corresponds to a respiratory parameter.

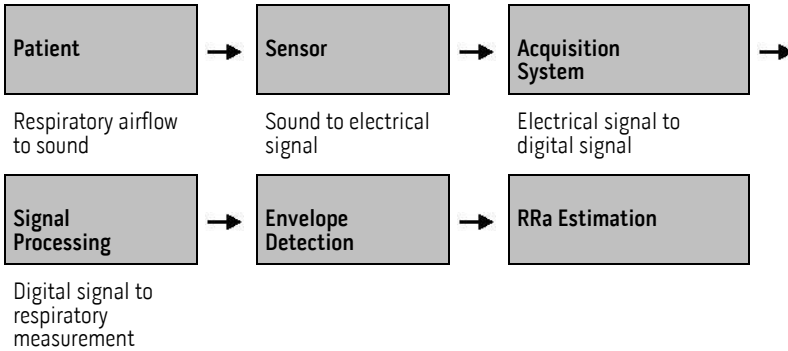

Patient

The generation of respiratory sounds is primarily related to turbulent respiratory airflow in upper airways. Sound pressure waves within the airway gas and airway wall motion contribute to the vibrations that reach the body surface and are recorded as respiratory sounds.

Although the spectral shape of respiratory sounds varies widely from person to person, it is often reproducible within the same person, likely reflecting the strong influence of individual airway anatomy [2-6].

Sensor

The sensor captures respiratory sounds (and other biological sounds) much like a microphone does. When subjected to a mechanical strain, (e.g., surface vibrations generated during breathing), the sensor becomes electrically polarized.

The degree of polarization is proportional to the applied strain. The output of the sensor is an electric signal that includes a sound signal that is modulated by inspiratory and expiratory phases of the respiratory cycle.

Acquisition System

The acquisition system converts the electric signal provided by the sensor into a digital signal. This format allows the signal to be processed by a computing device.

Signal Processing

The digital signal produced by the acquisition system is converted into a measurement that corresponds to the respiratory parameter of interest. As shown in the previous figure, this can be performed by, for example, determining the digital signal envelope or outline which in turn may be utilized to determine the respiratory rate. In this way, a real-time, continuous breath rate parameter can be obtained and displayed on a monitor which, in many cases, may be real-time and continuous.

The respiratory cycle envelope signal processing principle is similar to methods that sample airway gasses and subsequently determine a respiratory rate.

[1] A.R.A. Sovijärvi, F. Dalmaso, J. Vanderschool, L.P. Malmberg, G. Righini, S.A.T. Stoneman. *Definition of terms for applications of respiratory sounds. Eur Respir Rev* 2000; 10:77, 597-610.

[2] Z. Moussavi. *Fundamentals of respiratory sounds analysis. Synthesis lectures on biomedical engineering #8. Morgan & Claypool Publishers, 2006.*

[3] Olsen, et al. *Mechanisms of lung sound generation. Semin Respir Med* 1985; 6: 171-179.

[4] Pastercamp H, Kraman SS, Wodicka GR. *Respiratory sounds – Advances beyond the stethoscope. Am J Respir Crit Care Med* 1977; 156: 974-987.

[5] Gavriely N, Cugell DW. *Airflow effects on amplitude and spectral content of normal breath sounds. J Appl Physiol* 1996; 80: 5-13.

[6] Gavriely N, Palti Y, Alroy G. *Spectral characteristics of normal breath sounds. J Appl Physiol* 1981; 50: 307-314.

Chapter 2: Radical-7 Descriptions

The following chapter contains the Radical-7 descriptions, including descriptions of the Handheld monitor , the Standalone monitor, and the optional SatShare monitor interface.

General System Description

The Radical-7 system includes the following:

1. Instrument
2. Patient Cable
3. Sensor

Functionality of the Radical-7

The Radical-7 provides the functionality of three instruments in one:

Handheld Pulse CO-Oximeter

The Radical-7 is a fully featured Handheld.



The Handheld contains the majority of the device features. All measurements and instrument status datum are displayed on the touchscreen. All user input is performed through the touchscreen and control buttons. The sensor cable connector is located on the Handheld.

Standalone Pulse Oximeter

The Radical-7 is a fully featured Standalone Pulse-Oximeter, and Acoustic Monitor.



The Handheld snaps into the Docking Station to provide a fully featured standalone monitor. The Docking Station connects to AC power for standalone operation or charging of the Handheld. An optional Docking Station battery is available. The Standalone features Nurse Call, analog output, and serial output.

Monitor Interface

The Radical-7 interfaces to the SpO2 input module of multi-parameter patient monitors to upgrade conventional pulse oximetry technology on the multi-parameter monitor to Masimo SET technology.



Utilizing a SatShare cable, the standalone Radical-7 also interfaces with the SpO2 input of a validated multi-parameter patient monitor, instantly upgrading the conventional pulse oximetry to Masimo SET pulse oximetry. The SatShare cable attaches to the back of the Radical Docking Station, and SatShare cables are available to interface with most multi-parameter patient monitors.

Handheld

All user input and displays are controlled by this component. The patient cable connects into the connector on the Handheld instrument. The Handheld is battery powered and can be used either as a transport monitor or as a Handheld Pulse CO-Oximeter for spot checks.

Handheld Front Panel

The following figure numbers and corresponding table describes the hardware features of the Radical-7.



1 Handheld Release button

Press down the Handheld Release Button to pull the Handheld off the Docking Station.

2 Touchscreen Display

The Touchscreen Display refers to the interactive area on the Handheld. There are different Display Views that can appear in this area. For more about using the Touchscreen and Display Views, see *Changing the Size of Parameter Values* on page 50.

3 Profile button

The Profile button provides instant access to the Profile Screen. See *Chapter 5: Profiles* on page 89.

4 Power button

To turn on the Radical-7, press the Power button. To turn off, press and hold the button for more than 2 seconds.

5 Home button

The Home button provides instant access to the Display View screen.

6 Alarm Silence Button

The Alarm Silence button temporarily silences alarms. See *Silencing the Alarms* on page 95.

7 Speaker

The speaker indicates audio alarms. Care should be taken not to cover the speaker and muffle the audible alarm volume.

8 Patient Cable Connector

Connect a patient cable or a direct cable sensor into the Radical-7

Handheld Back Panel

The Handheld back panel features the connection to the Docking Station, an accessory mount for the pole clamp accessory, and access to the Handheld battery pack.

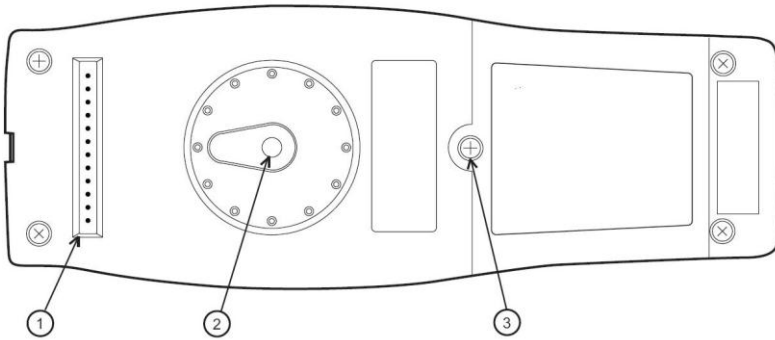

Item	Description
1	The Handheld interfaces with the Docking Station through this connector.
2	The optional Pole Clamp accessory attaches to this holder. See the directions for use of the Pole Clamp accessory for attachment instructions.
3	The Handheld is powered by a lithium ion battery located in this compartment. For battery care and replacement, see Battery Operation and Maintenance on page 123.

Standalone

When the Handheld is placed into the Docking Station, they become a full-featured standalone system. In this manual, when the Handheld and the Docking Station are connected, they are referred to *Standalone*. The Standalone acts as a battery charger for the Handheld and has AC power connection capabilities. If the AC power from the wall outlet is temporarily interrupted, then the battery in the Handheld allows for continuous operation. The Standalone can also interface with serial instruments, Nurse Call or analog output instruments, and multi-parameter patient monitors through a SatShare cable.





There are several models of compatible Docking Stations available: RDS-1, RDS-2, and RDS-3. The RDS-1 and RDS-3 are optionally available with SafetyNet capability. The following table lists which features are available for each model of Docking Station.

Docking Station Features	RDS-1	RDS-2	RDS-3
AC Power Input	■	■	■
SatShare Interface	■		
Serial RS-232 interface	■		■
Nurse Call/Analog Output interface	■		■
10-Hour Extended Battery			
Automatic Display Rotation Support (Gravity Detector)	■		■
Docking Station Battery Charging indicator			■
Handheld Battery Charging indicator	■	■	■
Visual Alarm indicator	■		■
AC Power indicator	■	■	■
Docking indicator	■		■

Standalone Front Panel

The following figure and corresponding text review the features of the Radical-7 Standalone. Note that when the Standalone is turned on, all indicator LEDs initially turn on and off at start up.



Item	Description		
1		Docking Station Battery Charging Indicator	The Docking Station Battery Charging indicator is illuminated when the Docking Station battery is charging. The indicator blinks just prior to charging. The Charging Indicator does not illuminate when the battery is fully charged or when the battery is not present.
2		Handheld Battery Charging indicator	The Handheld Battery Charging indicator is illuminated when the Handheld battery is charging. The indicator blinks just prior to charging. The Charging Indicator does not illuminate when the battery is fully charged or when the battery is not present.
3		Visual Alarm Indicator	The Visual Alarm indicator is illuminated when an alarm condition is active and the Alarm Status Indicator is shown.
4		AC Power Indicator	The AC Power indicator is illuminated when the Radical-7 Docking Station is plugged into AC line power.
5		Docking Indicator	The Docking indicator is illuminated when the Handheld instrument is turned on and is properly interfaced to a Docking Station.

Standalone Back Panel

The following figure and corresponding text review the features of the Radical-7 Standalone.

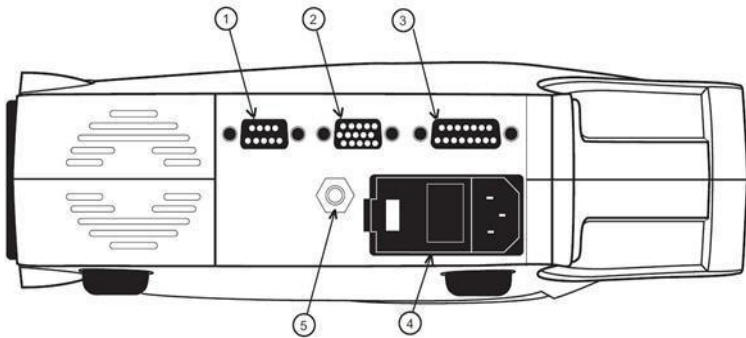

Item	Connector	Description
1	Serial Output connector	Use the Serial Output connector with a ferrite bead installed to connect a serial instrument, including a serial printer, a monitoring system or PC to the Radical-7. The data is provided in standard RS-232C format. All external instrument connections to the Serial Output connector must be IEC-60950 compliant.
2	Analog Output/Nurse Call connector	Use the Analog Output connector with a ferrite bead installed to interface with an analog output instrument, such as a chart recorder or Nurse Call system. All external instrument connections to the Analog Output/Nurse Call connector must be IEC-60950 compliant. See <i>Serial Interface Specifications</i> on page 115.
3	SatShare Cable connector	Use the SatShare Cable connector to connect a SatShare cable to the SpO2 input connector of a multi-parameter patient monitor. All external instrument connections to the SatShare Cable Connector must be IEC-60601-1-1 compliant. SatShare cables are available to interface with most major multi-parameter patient monitors. Check the label on the SatShare cable and the SatShare Directions for Use to ensure that the correct cable is used for each type of patient monitor. Visit www.masimo.com for the latest SatShare cables and validated instruments.

Item	Connector	Description
4	Power Entry module	The Power Entry module contains the input connector for AC power and two fuses. The AC input provides power to the system from the AC line. Always connect the Radical-7 to the mains power for continuous operation and/ or battery recharging. Note: Use the power cord as the means to disconnect the instrument from the mains power supply.
5	Equipotential Ground connector	Use the Equipotential Ground connector for grounding.

Monitor Interface With SatShare

The Radical-7 has a unique SatShare interface that links to most existing multi-parameter patient monitors through a SatShare cable.



- Upgrades any approved and validated monitor to Masimo SET performance by using the calculated SpO2 and pulse rate determined by Radical-7 to simulate an ideal plethysmograph waveform, which is sent to the validated multi-parameter patient monitor.
- Connects into the SpO2 patient cable or SpO2 input connector of the multi-parameter patient monitor.

See **Setting Up and Using SatShare** on page 44.

Chapter 3: Setup

The following chapter contains information about setting up the Radical-7 before use.

Unpacking and Inspection

To unpack and inspect the device

1. Remove the instrument from the shipping carton and examine it for signs of shipping damage.
2. Check all materials against the packing list. Save all packing materials, invoice and bill of lading. These may be required to process a claim with the carrier.
3. If anything is missing or damaged, contact the Technical Service Department. See **Return Procedure** on page 128.

Docking Station Power Requirements

- Always use a hospital-grade, AC power cable to connect the Docking Station to an AC power source.
- Do not connect the Docking Station to an AC outlet that is controlled by a switch because the power to the Docking Station may be inadvertently switched off.
- Verify the AC power voltage and line frequency before use.
- Verify that the power source can provide an adequate power rating as indicated on the rear panel of the Docking Station.
- The Radical-7 is designed to operate on 100 to 240VAC, 47-63 Hz.
- The Radical-7 is rated at 55 VA max.
- Connect a hospital-grade power cable (IEC-320 connector type at the instrument) to the Power Entry module on the Docking Station.
- Connect the power cable to an AC power source.
- Ensure that the instrument is adequately powered by verifying that the AC power indicator on the Docking Station is illuminated.

See **Safety Information, Warnings, and Cautions** on page 11.

Setting Up the Docking Station

Place the Docking Station on a stable hard flat surface near the patient. Always place the Radical-7 on a dry surface. Maintain a minimum of 3 cm (1 inch) free space around the Radical-7. Make sure that the Radical-7 speaker is not covered to avoid a muffled alarm sound.

The Radical-7 Handheld, Docking Station or Standalone should not be operated outside the environmental conditions listed in the specifications section **Environmental** on page 111.

Initial Battery Charging

Before use, the Radical-7 Handheld battery and the Docking Station battery must be charged completely. See **Electrical Safety Information, Warnings, and Cautions** on page 17.

To charge the Handheld and Docking Station for the first time

1. Attach the Handheld to the Docking Station.
2. Plug in the AC power cord to power entry module. Make sure it is securely plugged in.
3. Plug the AC power cord into an AC power source.
4. Verify that the batteries are charging.
 - The Battery Charging indicators on the Docking Station flash prior to charging and remain illuminated while the batteries are charging.

See **Standalone Front Panel** on page 38 and **Battery Operation and Maintenance** on page 123.

Setting Up for Philips, Agilent, or HP VueLink

To set up for use with VueLink compatible monitors (Philips, Agilent, or HP)

1. On the Radical-7, on the *device output* screen, for the *serial* option, select **Hp VueLink**.
2. Connect one end of the VueLink cable to the Serial Output connector on the Docking Station.
3. Connect the other end of the VueLink cable to the VueLink module and insert the module into the VueLink compatible monitor rack.

The SpO₂ and pulse rate values appear on the VueLink compatible monitor.
4. In order for the plethysmographic waveform to be displayed on the VueLink compatible monitor, and for the VueLink monitor to convey alarm conditions measured by the Radical-7, the VueLink compatible monitor must be properly configured.
5. See instructions for use provided with the VueLink compatible monitor and the VueLink module. See **Device Related Safety Information, Warnings, and Cautions** on page 14 and **Serial Interface Specifications** on page 115.

Setting Up for SpaceLabs Flexport

To set up for use with SpaceLabs Flexport

1. On the Radical-7, on the *device output* screen, for the *serial* option, select **SpaceLabs Flexport**.
2. Connect one end of the Spacelabs Flexport cable to the Serial Output connector on the Docking Station.
3. Connect the other end of the Spacelabs Flexport cable to the Spacelabs Universal Flexport connector.

The SpO2 and pulse rate values appear on the Spacelabs screen.

4. In order for the plethysmographic waveform to be displayed on the Spacelabs screen, and for the Spacelabs monitor to convey alarm conditions measured by the Radical-7, the Spacelabs monitor must be properly configured.
5. See instructions for use provided with the Spacelabs monitor. See **Device Related Safety Information, Warnings, and Cautions** on page 14 and **Serial Interface Specifications** on page 115.

Setting Up and Using SatShare

Parameter values from the Radical-7 can be displayed on a multi-parameter monitor through the SatShare feature. The SatShare feature provides an ideal, simulated plethysmographic waveform that corresponds to the parameter values determined by the Radical-7. This waveform may be used to display these values on multi-parameter monitors through the multi-parameter oximetry sensor or input connector.

It is recommended that the Radical-7 be positioned near the multi-parameter monitor, with the Radical-7 screen displaying the plethysmographic waveform and the parameter values. Refer to the instructions for use provided with the multi-parameter monitor. See **Device Related Safety Information, Warnings, and Cautions** on page 14.

To set up for use with SatShare interface

1. Select the SatShare cable that is appropriate for the multi-parameter monitor. For the latest list of available SatShare cables and validated instruments, see www.masimo.com.
2. Connect the labeled end of the SatShare cable to the SatShare Cable connector on the Docking Station. See **Standalone Back Panel** on page 39. For a secure connection, tighten the cable connector screws.
3. Connect the other end of the SatShare cable to one of the following:
 - Sensor connector of the multi-parameter monitor cable
 - Directly to the multi-parameter monitor
4. Verify that the Radical-7 recognizes the SatShare cable. If functional, the name of the SatShare cable displays on the Radical-7 screen.
5. As appropriate, configure alarm limits on the multi-parameter monitor.
6. Set the averaging time for the multi-parameter monitor to its lowest setting (or fastest response). The ideal waveform for the Radical-7 requires additional averaging by the monitor. If the averaging time of the multi-parameter monitor is not changed, the time to display physiological changes in saturation on the monitor is increased with SatShare. However, the delay can be minimized by reducing the averaging time on the multi-parameter monitor.
7. While in the SatShare mode, if there are any significant discrepancies between the readings from Radical-7 and those on the monitor displaying the values obtained from SatShare, the values reported by the Radical-7 are to be considered the correct values.
8. It is possible to use the Radical-7 with SatShare while the Radical-7 is not connected to AC power. However, in this configuration, battery run time is reduced. See **Battery Operation and Maintenance** on page 123.
9. On the Radical-7, turn on the *Satshare Numbers* option. See **Device Output** on page 76.
10. If displaying the simulated waveform is not desirable, it is recommended to turn off the plethysmographic waveform display of the multi-parameter patient monitor. See **Serial Interface Specifications** on page 115.

Chapter 4: Operation

The following chapter contains information about using the Radical-7.

Using the Touchscreen and Buttons



1. **Display View**
To access other screens, touch a value on the Display View. See **About the Display View** on page 48.
2. **Profiles button**
To access the *Profiles* screen, press Profiles. See **Chapter 5: Profiles** on page 89.
3. **Alarm Silence button**
To temporarily silence audible alarms, press Alarm Silence. See **Silencing the Alarms** on page 95.
4. **Home button**
To return to the *Display View*, press Home.
5. **Power button**
To turn on the Radical-7, press the Power button. To turn off, press and hold the button for more than 2 seconds

Using Screen Lock

When turned on, the *Screen Lock* feature may prevent unintentional interaction with *Display View*.

Using the Screen Lock feature

1. When turned on, any interaction with the *Display View* triggers the Screen Lock feature.
2. To bypass *Screen Lock* when it appears, press and hold the Lock icon until it unlocks.



3. To turn on or turn off *Screen Lock*, see **Access Control** on page 72.

Using the Home Button

One option to return to *Display View* is by using the Home button.

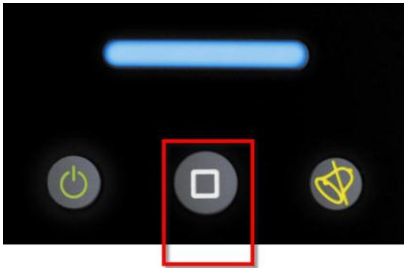

To return to Display View using the Home button

- From any screen, press **Home**.

Navigating the Radical-7

Navigate the Radical-7 screens via the *Display View* or the *Main Menu*.

Display View

The following is the primary interactive screen that the user views.

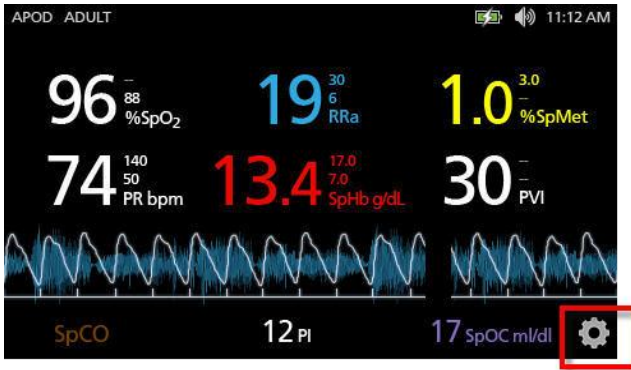

To access the *Main Menu* screen

- Touch the gear icon at the lower right corner of the display.

Main Menu

The following is the *Main Menu* screen where users can access additional screens and information. Users can swipe the screen left or right to pan the Menu Icons. Users can touch the arrow icon to return to the *Display View*. See **Accessing the Main Menu** on page 57.



Display Timeout

When no user interaction occurs within 1 minute, the display times out and returns to the *Display View*.

About the Display View

The *Display View* consists of different areas:

Status Bar. See *About the Status Bar* on page 49.



Parameter Display. See *Changing the Size of Parameter Values* on page 50.



Trend Field. See *Waveform and Trend Views* on page 52.

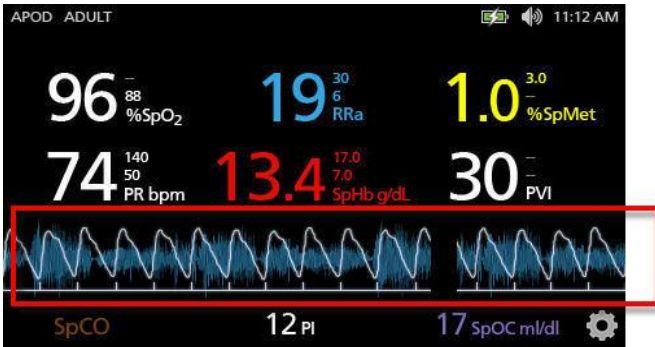

Small Parameter View. See *Accessing the Main Menu* on page 57.

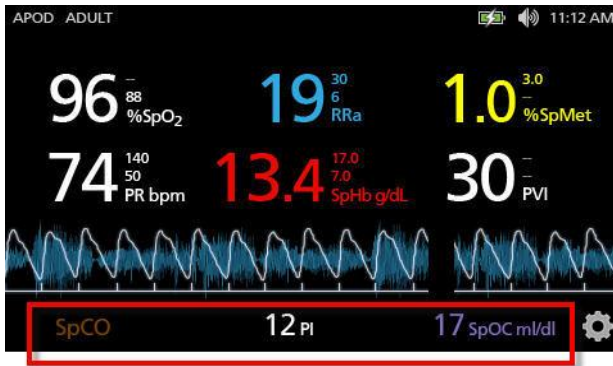

About the Status Bar

The Status Bar is visible on the top portion of the *Display View*.



Status Bar

Access additional screens, more information, or toggle features by touching directly on any of the following indicators in the Status Bar.

- Sensitivity Modes. See *Sensitivity Modes Overview* on page 55.
- Profiles. See *Profiles Overview* on page 89.
- **Messages** on page 99. (read only)
- **WiFi** on page 75.
- **Battery** on page 76.
- **Sounds** on page 70.
- Time settings. See *Localization* on page 74.

Changing the Size of Parameter Values

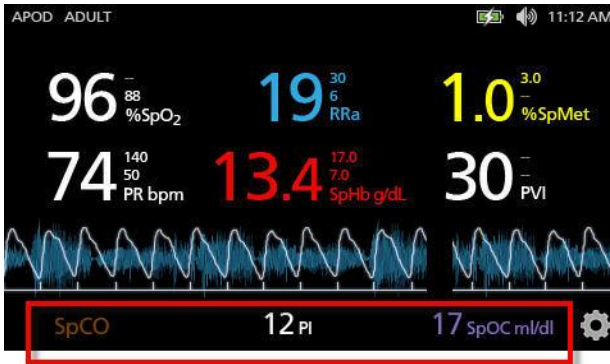

To change the size of parameter values on the Display View

1. On the *Small Parameter* view, touch and hold any one of the parameters, as shown above.
2. When the parameter value dims, shakes, and grows in size, drag and drop that parameter above the *Trend Field*.
3. The parameter value appears on the screen in a larger font. The device automatically configures the screen for optimal display of the parameter values.
4. To remove parameter values from the larger font display, press and hold the larger parameter value. Then drag and drop the parameter value back to the *Small Parameter* view.

Trend Field

The *Trend Field* allows users to access various customizable views. See **Trends** on page 77.

To access trend, waveform, or customize the views on the Display View screen

1. Touch the **Trend Field**, as shown below.

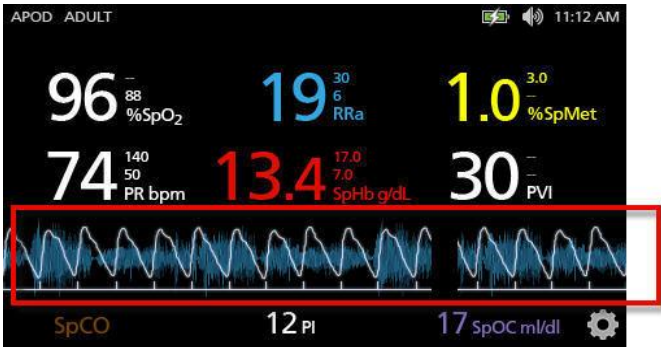

2. The following screen appears.

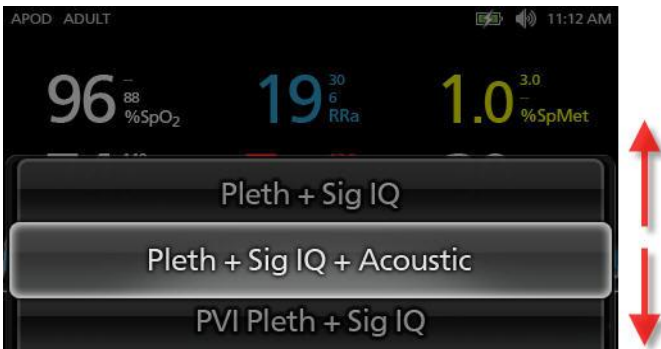

3. Swipe up or swipe down the available options.
4. Touch on the desired option.
5. The *Trend Field* displays trend data specific to the option that was selected.

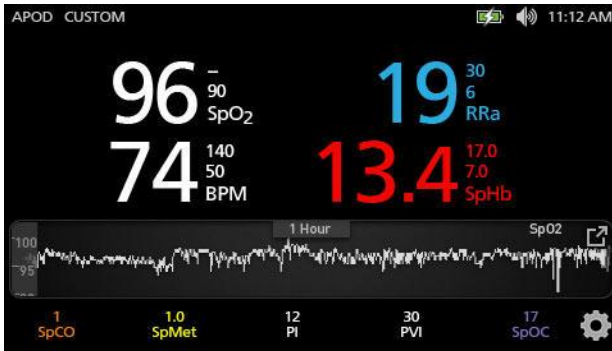

Pulse Bar

The *Pulse Bar* is a visual indicator that conveys the detection of pulse and the Signal IQ (SIQ) displayed on each individual pulsation. The height of the bars provides an assessment of the confidence in the measurement displayed. See *Signal IQ Indicators* on page 53.



Waveform and Trend Views

The following section contain information about trends and waveforms available from the *Trend Field* on the *Display View* screen. The following are examples of some of the views that are available.

Pleth + Sig IQ View

Shows the parameter values on the top of the screen. The waveform is located below the parameter values. The *Small Parameter* view is located along the bottom of the screen. This view contains the Pleth Waveform with signal quality indications only.

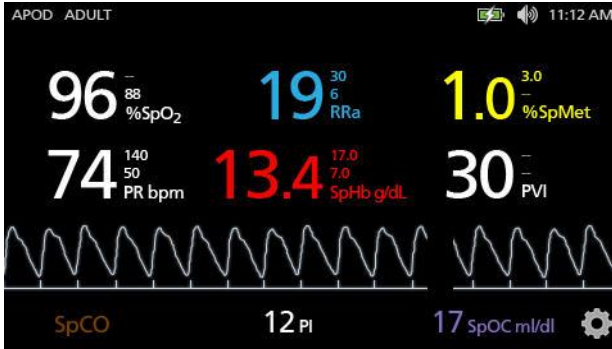

Signal IQ Indicators

The Signal IQ (SIQ), displayed on each individual pulsation, is conveyed by vertical bars, as shown below. The height of the bar provides an assessment of the confidence in the measurement displayed.

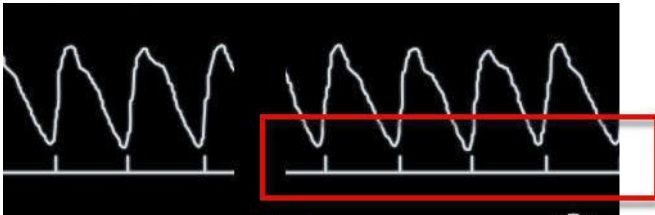

Acoustic Waveform View

Shows the parameter values on the top of the screen. The RRA waveform is located below the parameter values. The *Small Parameter* view is located along the bottom of the screen. Acoustic Respiratory Rate (RRA) must be available for this feature to be shown. This view contains acoustic respiratory rate waveform only.

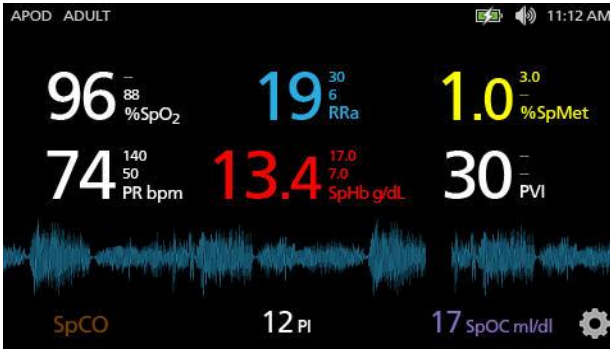

Pleth + Sig IQ + Acoustic View

Shows the parameter values on the top of the screen. The waveform is located below the parameter values. The *Small Parameter* view is located along the bottom of the screen. This view contains the Pleth waveform, signal quality indications, and acoustic waveform.

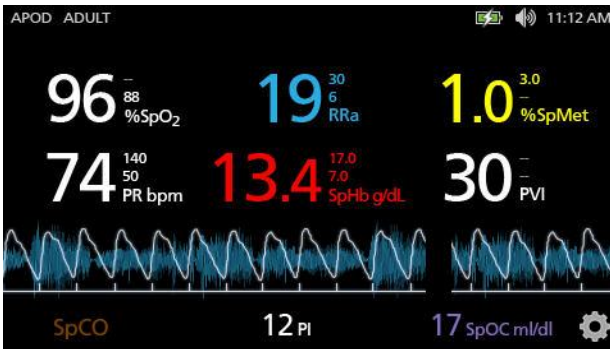

Parameter Quick Trend View

This view displays the quick trend of the selected parameter over an adjustable period of time. The default is 1 hour. Enlarge the quick trend to the full trend view by touching the expand icon of the waveform display.

With a pinch gesture, using two fingers, the user can zoom in and out of the quick trend data within the *Trend Field*.



Sensitivity Modes Overview

Three sensitivity levels enable a clinician to tailor the response of the Radical-7 to the needs of the particular patient situation. Access the menu by touching on the indicator in the upper left corner of the *Display View*. The sensitivity levels are as follows:

- NORM (Normal Sensitivity)**
 NORM is the recommended sensitivity mode for patients who are experiencing some compromise in blood flow or perfusion. It is advisable for care areas where patients are observed frequently, such as an intensive care unit (ICU).
- APOD (Adaptive Probe Off Detection Sensitivity)**
 APOD is the recommended sensitivity mode where there is a high probability of the sensor becoming detached. It is also the suggested mode for care areas where patients are not visually monitored continuously. This mode delivers enhanced protection against erroneous pulse rate and arterial oxygen saturation readings when a sensor becomes inadvertently detached from a patient due to excessive movement.
- MAX (Maximum Sensitivity)**
 MAX is recommended sensitivity mode for patients with low perfusion or when a *low perfusion* message displays in APOD or NORM mode. MAX mode is not recommended for care areas where patients are not monitored visually, such as general wards. It is designed to interpret and display data at the measuring site when the signal may be weak due to decreased perfusion. When a sensor becomes detached from a patient, it will have compromised protection against erroneous pulse rate and arterial saturation readings.

Changing Sensitivity Modes

There are two ways to change the sensitivity modes.

1. Press the indication on the top left of the *Display View*.

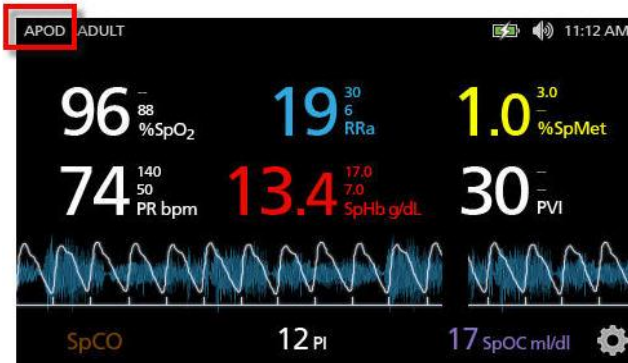

2. Alternatively, from the *Main Menu*, touch the *Profiles* icon. From the *Profiles* screen, select the desired mode by scrolling up or down. Then select **OK**.

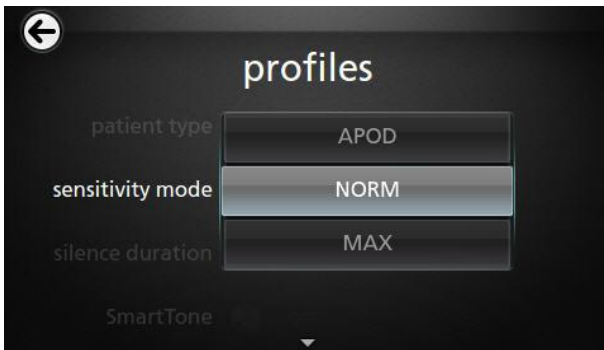

Note that the device will revert to APOD mode after a power cycle.

See **Changing Profiles** on page 90.

Accessing the Main Menu

To access *Main Menu* from the *Display View*, touch the gear icon on the bottom right corner of the *Small Parameter View*.

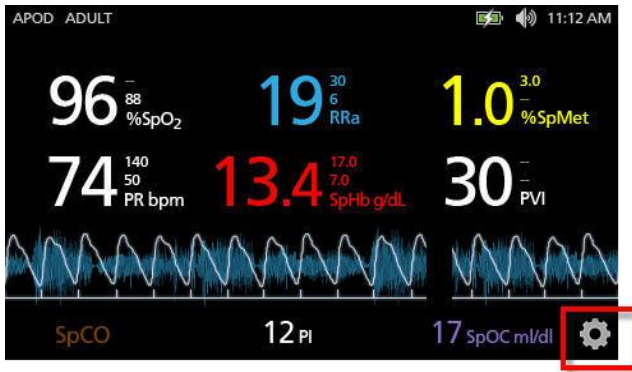

Navigating the Main Menu



- From the *Main Menu* screen, touch the icons for any of the following screens:



Device Settings

See *Device Settings* on page 71.



Parameter Settings

See **Parameter Settings** on page 59.



Profiles

See **Changing Profiles** on page 90.



3D Alarms

See **3D Alarms** on page 97.



Trends

See **Trends** on page 77 and **Trend Field** on page 51.



Sound

See **Sounds** on page 70.



About

See **About** on page 87.

Parameter Settings



The following is an example of the *Parameter Settings* screen. Only parameters that have been loaded onto the system will be visible.



To access any of the available parameter setting screens

1. From the *Parameter Settings* screen, to access the desired parameter, flick the on-screen icons left or right.
2. Touch the icon of the desired parameter. For details, see any of the following sections.

SpO2 Settings on page 60.

SpfO2 Settings.

SpHb Settings on page 62.

PVI Settings on page 67.

PR Settings on page 63.

Perfusion Index (PI) Settings on page 64.

SpCO Settings on page 67.

SpMet Settings on page 68.

SpOC Alarms on page 69.

Respiration Rate (RR) on page 65.

About Parameter Information

Additional information about each parameter is available.

To access additional information about parameters

1. From the parameter settings screen, touch the **About** icon. The following is an example for SpHb.



2. An *About* screen appears for the selected parameter.

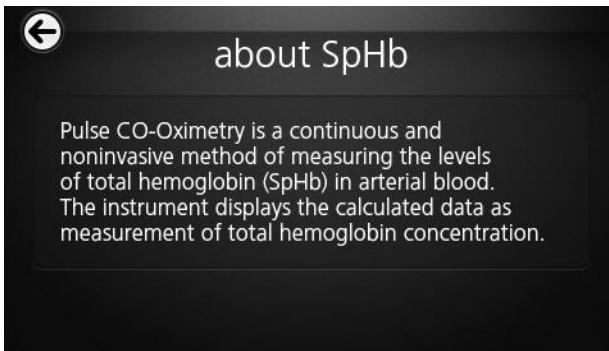

SpO2 Settings

Access any of the following options:

Alarms for SpO2 on page 61.

Additional Settings for SpO2 on page 61.

About Parameter Information on page 60.

Alarms for SpO2

From the *Alarms* screen, change any of the following options:

Options	Description	Factory Default Settings	Configurable Options
High Limit	High Limit is the upper threshold that triggers an alarm.	Off	2% to 99% in steps of 1% When set to Off, alarm is disabled
Low Limit	Low Limit is the lower threshold that triggers an alarm.	88%	1% to 98% in steps of 1%
Rapid Desat	Sets the Rapid Desat limit threshold to the selected amount below the Low Alarm Limit. When SpO2 value falls below rapid desat limit the audio and visual alarm are immediately triggered without respect to the alarm delay.	-10%	Off, -5%, or -10%
Alarm Delay	When an alarm condition is met, this feature delays the audible part of an alarm.	5 seconds	0, 5, 10, or 15 seconds

Additional Settings for SpO2

From the *Additional Settings* screen, change any of the following options:

Options	Description	Factory Default Settings	User Configurable Settings
Averaging Time	The length of time over which the system calculates the average of all data points.	8 seconds	2-4, 4-6, 8, 10, 12, 14, or 16 seconds
FastSat	See FastSat Overview on page 64.	Off	On or Off

SpHb Settings

From the *SpHb Settings* screen, access any of the following screens:

SpHb Alarms on page 62.

Additional Settings for SpHb on page 63.

About Parameter Information on page 60.

SpHb Alarms

From the *Alarms* screen, change any of the following options:

Options	Description	Factory Default Settings	User Configurable Settings
High Limit	The High Limit is upper threshold that triggers an alarm.	17.0 g/dL (11.0 mmol/L)	2.0 g/dL to 24.5 g/dL in steps of 0.1 g/dL, or Off (2.0 mmol/L to 15.0 mmol/L in steps of 0.1 mmol/L, or Off) When SpHb Precision is set to 1.0, the values are rounded down. When set to Off, alarm is disabled.
Low Limit	The Low Limit is lower threshold that triggers an alarm.	7.0 g/dL (4.0 mmol/L)	Off, or 1.0 g/dL to 23.5 g/dL in steps of 0.1 g/dL (Off, or 1.0 mmol/L to 14.5 mmol/L, in steps of 0.1 mmol/L) When SpHb Precision is set to 1.0, values are rounded down. When set to Off, alarm is disabled.

Additional Settings for SpHb

From the *Additional Settings* screen, change any of the following options:

Options	Description	Factory Default Settings	User Configurable Settings
Averaging Time	The length of time over which the system calculates the average of all data points.	Medium	Short, Medium, or Long
Calibration	Provides an arterial or venous value that displays on the main screen.	Venous	Arterial or Venous
Precision	Allows the user to set the decimal for SpHb.	0.1	0.1, 0.5, or 1.0 (whole numbers)
Unit of Measure	Displays total hemoglobin (SpHb) as g/dL (grams per deciliter) or mmol/L (millimoles per liter).	g/dL	mmol/L or g/dL

PR Settings

From the *PR Settings* screen, change any of the following options:

PR Alarms on page 63.

About Parameter Information on page 60.

PR Alarms

From the *PR Alarms* screen, change any of the following options:

Options	Description	Factory Default Settings	Options
High Limit	The High Limit is upper threshold that triggers an alarm.	140 bpm	35 bpm to 235 bpm, in steps of 5 bpm
Low Limit	The Low Limit is lower threshold that triggers an alarm.	50 bpm	30 bpm to 230 bpm, in steps of 5 bpm

FastSat Overview

FastSat enables rapid tracking of arterial oxygen saturation changes. Arterial oxygen saturation data is averaged using pulse oximeter averaging algorithms to smooth the trend.

When the Radical-7 is set to FastSat *On*, the averaging algorithm evaluates all the saturation values providing an averaged saturation value that is a better representation of the patient's current oxygenation status. With FastSat, the averaging time is dependent on the input signal.

Perfusion Index (PI) Settings

From the *PI Settings* screen, access any of the following screens:

PI Alarms on page 64.

Additional Settings for PI on page 65.

About Parameter Information on page 60.

PI Alarms

From the *Alarms* screen, change any of the following options:

Options	Description	Factory Default Settings	User Configurable Settings
High Limit	The High Limit is upper threshold that triggers an alarm.	Off	Step size: 0.04 to 0.09 in steps of 0.01 0.10 to 0.90 in steps of 0.10 1 to 19 in steps of 1, or Off
Low Limit	The Low Limit is lower threshold that triggers an alarm.	Off	Step size: Off, or 0.03 to 0.09 in steps of 0.01 0.10 to 0.90 in steps of 0.10 1 to 18 in steps of 1

Additional Settings for PI

From the *Additional Settings* screen, change any of the following options:

Options	Description	Factory Default Settings	User Configurable Settings
Averaging Time	The length of time over which the system calculates the average of all data points.	Long	Short or Long

Respiration Rate (RR)

The Radical-7 can determine respiration rate (RR) either by the acoustic signal (RRa) or, if installed, by the plethysmographic waveform (RRp).

When using an acoustic sensor, respiration rate (RR) is determined by the acoustic (RRa) signal. When the respiratory rate is determined by the acoustic signal, the *Display View* conveys respiratory rate as *RRa*, as shown below.



RRa Settings

RRa is active under the following conditions:

- RRa is installed on the Radical-7.
- Dual Rainbow cable is connected.
- Acoustic sensor is connected.

From the *RR Settings* screen, access any of the following screens:

RRa Alarms on page 66.

Additional Settings for RRa on page 66.

About Parameter Information on page 60.

RRa Alarms

From the *Alarms* screen, change any of the following options:

Options	Description	Factory Default Settings	Configurable Options
High Limit	The High Limit is upper threshold that triggers an alarm.	30 breaths per minute	6 to 69 breaths per minute in steps of 1 breaths per minute, or Off
Low Limit	The Low Limit is lower threshold that triggers an alarm.	6 breaths per minute	5 to 68 breaths per minute in steps of 1 breaths per minute
Respiratory Pause	The duration of time that triggers an alarm if no breaths are detected.	30 seconds	20, 25, 30, 35, 40, or 15 seconds
Alarm Delay	When a High or Low alarm condition occurs, this feature delays the audible part of an alarm.	30 seconds	60, 0, 10, 15, or 30 seconds

Additional Settings for RRa

From the *Additional Settings* screen, change any of the following options:

Options	Description	Factory Default Settings	User Configurable Settings
Averaging Time	The length of time over which the system calculates the average of all data points.	Slow	Trending, No, Fast, Medium, or Slow
Freshness	The duration of time that, during interference, the system displays the last valid reading.	5 minutes	10, 15, 0, 1, or 5 minutes

PVI Settings

From the *PVI Settings* screen, access any of the following options:

PVI Alarms on page 67.

Additional Settings for PVI on page 67.

About Parameter Information on page 60

PVI Alarms

From the *Additional Settings* screen, change any of the following options:

Options	Description	Factory Default Settings	User Configurable Settings
High Limit	The High Limit is upper threshold that triggers an alarm.	Off	2 to 99, in steps of 1, or Off When set to Off, alarms are disabled.
Low Limit	The Low Limit is lower threshold that triggers an alarm.	Off	Off, 1 to 98 in steps of 1 When set to Off, alarms are disabled.

Additional Settings for PVI

From the *Additional Settings* screen, change any of the following options:

Options	Description	Factory Default Settings	User Configurable Settings
Averaging Time	The length of time over which the system calculates the average of all data points.	Long	Short or Long

SpCO Settings

From the *SpCO Settings* screen, access the following screens:

SpCO Alarms on page 68.

About Parameter Information on page 60.

SpCO Alarms

From the *SpCO Settings* screen, access the following screens:

Options	Description	Factory Default Settings	User Configurable Settings
High Limit	The High Limit is the upper threshold that triggers an alarm.	10	2% to 98%, in steps of 1%, or Off When set to Off, alarm is disabled
Low Limit	The Low Limit is the lower threshold that triggers an alarm.	Off	Off, 1% to 97%, in steps of 1% When set to Off, alarm is disabled

SpMet Settings

From the *SpMet Settings* screen, access the following screens:

SpMet Alarms on page 68.

About Parameter Information on page 60.

SpMet Alarms

From the *Alarms* screen, change any of the following options:

Options	Description	Factory Default Settings	User Configurable Settings
High Limit	The High Alarm Limit is upper threshold that triggers an alarm.	3.0	1% to 2% in steps of 0.1% 2.5% to 99.5% in steps of 0.5%, or Off
Low Limit	The Low Alarm Limit is lower threshold that triggers an alarm.	Off	Off, 0.1% to 2.0% in steps of 0.1% 2.5% to 99%, in steps of 0.5%

SpOC Settings

From the *SpOC Settings* screen, access the following screens:

SpOC Alarms on page 69.

About Parameter Information on page 60.

SpOC Alarms



From the *SpOC Alarms* screen, access the following screens:

Options	Description	Factory Default Settings	User Configurable Settings
High Limit	The High Limit is the upper threshold that triggers an alarm.	Off	2% to 34% in steps of 1%, or Off
Low Limit	The Low Limit is the lower threshold that triggers an alarm.	Off	Off, or 1% to 33% in steps of 1%

Sounds



From the *Sounds* screen, change any of the following options:

Options	Description	Factory Default Settings	User Configurable Settings
Alarm Volume	Sets the alarm volume and provides a sample of the alarm volume.	Level 4	Level 1 to 4
Pulse Tone Volume	Sets the volume of the tone that conveys the pulse rate.	Level 3	Off, Level 1 to 4
Silence Duration	Length of time that the audible alarm remains muted.	120 seconds	<p>30, 60, 90, or 120 seconds</p> <p>If <i>All Mute</i> is set to <i>On</i> (see Access Control on page 72), then the following additional settings become available:</p> <p><i>All Mute</i> If selected, then no alarms will sound. Only visual elements are enabled. The following icon appears on the <i>Display View</i>.</p>  <p><i>All Mute with Reminder</i> If selected, then no alarms will sound. Only visual elements are enabled. A tone sounds every 3 minutes as a reminder. The following icon appears on the <i>Display View</i>.</p> 

Device Settings



The following is an example of the *Device Settings* screen.



From the *Device Settings* screen, access any of the following options:

Screen Orientation on page 75.

Localization on page 74.

WiFi on page 75.

Battery on page 76.

Brightness on page 76.

Access Control on page 72.

Device Output on page 76.

Access Control

The *Access Control* screen is protected by a *Password* screen.

Password Screen

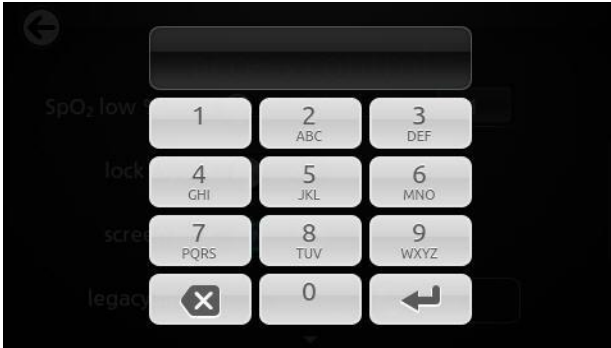

Using the Password screen

1. On the *Password* screen, enter the following numbers: **6 2 7 4**
No numbers will be displayed, only asterisks (****).
2. Touch **Enter**.



3. To undo numbers, touch **Backspace**.



Access Control Screen

From the *Access Control* screen, change any of the following options:

Options	Description	Factory Default Settings	User Configurable Settings
All Mute	All patient alarm conditions are silenced. Only system alarms will be indicated by an audible alarm.	Disabled	Enabled or disabled If enabled, <i>All Mute</i> and <i>All Mute with Reminder</i> become available settings from the <i>Silence Duration</i> option on the <i>Sounds</i> screen. See Sounds on page 70.
Lock Alarm Volume	When set to 3 or 4, 3 or 4 shows dimly lit in the Alarm Volume section of the Alarms Menu screen and cannot be changed.	Off	3, 4, or Off
SpO2 Low % Limit	Threshold at which SpO2 Low Alarm Limit cannot be reduced.	Off	1% to 98% in steps of 1, or Off
Lock Layout	Prevents the user from making changes to the parameter layout.	N/A	On or Off
Screen Lock	Prevents unintentional interaction with <i>Display View</i> .	On	On or Off
Legacy Mode	Changes the Display View from color to monochrome.	Color	Mono or Color
Save as Adult	Saves pre-configured profiles for adult patients.	N/A	Press Save to load all device configuration settings to adult profile.
Save as Neo	Saves pre-configured profiles for neonatal patients	N/A	Press Save to load all device configuration settings to neonatal profile.

Factory Defaults	Options are restored to factory values.	N/A	Press Restore to return to factory default values.
------------------	---	-----	---

Localization

From the *Localization* screen, change any of the following options:

Options	Description	Factory Default Settings	User Configurable Settings
Current Date	Date	N/A	N/A
Current Time	Time	N/A	N/A
Language	Language in which the screens display.	English	Choose from available languages.
Time Zone	Setting based on Coordinated Universal Time (UTC).	A (UTC+1hr)	Choose local time zone settings.
Date Format	Set the format of the date display on the Display View.	MM/DD/YYYY	MM/DD/YYYY DD/MM/YYYY
Time Format	Set the format of the time display as it will be shown on the Display View.	12 hour	24 hour or 12 hour
Line Frequency	Set to match regional power line frequency to allow for cancelation of noise introduced by fluorescent lights and other sources.	60 Hz	50 Hz or 60 Hz
Date	Manually set the numerical date if Auto Set Date/Time is Off.	MM/DD/YYYY	Choose month, date, and year.
Time	Manually set the hour and minute, AM or PM, if Auto Set Date/Time is Off.	12-hour format	Choose hour and minute.

Screen Orientation

From the *Screen Orientation* screen, change any of the following options:

Options	Description	Factory Default Settings	User Configurable Settings
Auto Orientation	Allows the device to automatically adjust the <i>Display</i> screens depending on orientation.	On	Off or On
Orientation	Rotates the viewing screens depending on device orientation.	Landscape	<p><i>Landscape</i>: rotates the screen to horizontal viewing position</p> <p><i>Inverted Landscape</i>: rotates the screen to (180 degree) viewing position</p> <p><i>Portrait</i>: rotates the screen to vertical viewing position</p> <p><i>Inverted Portrait</i>: rotates the screen to vertical (180 degree) viewing position</p>

WiFi

When the Radical-7 is connected to a WiFi network, the WiFi icon located on the Status Bar conveys the strength of the WiFi connection. See ***About the Status Bar*** on page 49.

From the *Wifi* screen, change any of the following options:

Options	Description	Factory Default Settings	User Configurable Settings
WiFi	Enables or disables the wireless connection	Off	On or Off
Additional fields in the Wifi screen provide information about WiFi connection. These additional fields are read only and not configurable.			

Battery

From the *Battery* screen, view the following information:

- Battery icon that conveys remaining battery charge as a green color.
- Battery icon that conveys that battery charging status. See **About the Status Bar** on page 49.

See **Battery Operation and Maintenance** on page 123.

Brightness

From the *Brightness* screen, change any of the following options:

Options	Description	Factory Default Settings	User Configurable Settings
Brightness	The slider option adjusts the brightness level of the display and provides a sample of the brightness level.	4	Level 1 to 4

Device Output

From the *Device Output* screen, change any of the following options:

Options	Description	Factory Default Settings	User Configurable Settings
Serial	Output to serial devices from the Serial Output connector is RS-232 based. See Standalone Back Panel on page 39.	ASCII 1	ASCII 1, IAP, HP Vuelink, SpaceLabs Flexport, or Data Collection
Analog 1	An interface with various analog recording instruments and/or strip chart recorders through connector located on Docking Station.	N/A	SpO2 50% to 100%, Pulse rate, Pleth, SIG, OV Output, 1V Output, SpO2 0% to 100%

Analog 2	Depending on the configuration, the following parameters are output continuously on the Analog 1 and Analog 2.	N/A	Pleth, SIQ, 0V Output, 1V Output, SpO2 0% to 100%, SpO2 50% to 100%, or Pulse rate
Nurse Call Trigger	The nurse call output will be activated based on the alarm events. The nurse call will be activated based on Low Signal or Alarm and Low Signal IQ events.	N/A	Alarms + SIQ, SIQ, Alarms
Nurse Call Polarity	Can be inverted to accommodate various nurse call station requirements.	N/A	Normal or Inverted

Trends



The following sections describe Trend Views and how to adjust trend settings.

About Trend Views

There are different ways to view trend information. The following is an example of trend information for SpO2 as it appears within the *Display View* screen.

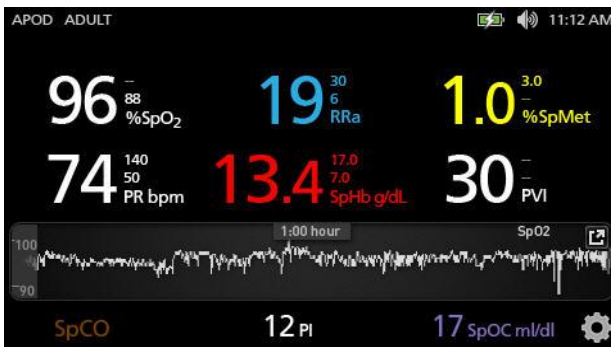

The following is an example of trend information for SpO2 as it appears in the *Full Trend* screen.



Changing Between Trend Views

To toggle between Display View and Full Trend

From the *Display View*, in the *Trend Field*, touch the icon as shown below.



From the *Full Trend* screen, touch the icon as shown below.



Manipulating Trend Data

To manipulate the view of trend data

On the *Full Trend* screen, with a pinch gesture, using two fingers, the user can zoom in and out of the trend time scale.

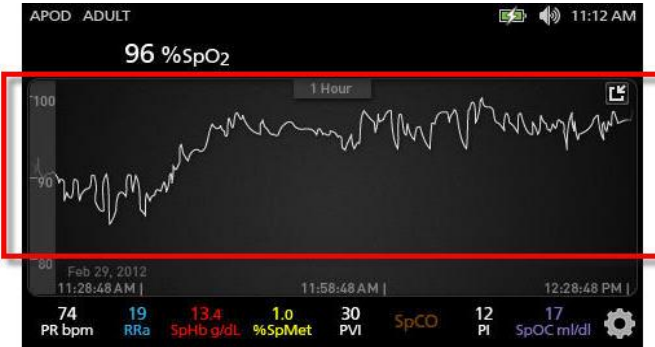

The user can add parameters to the *Trend* view by dragging and dropping parameters from the *Small Parameter* view. To add a parameter to the *Trend* view, press and hold any of the parameters inside the *Small Parameter* view, as shown below. When the parameter dims, shakes, and grows in size, drag and drop the parameter into the *Trend* view.



To view past patient trend data, swipe the trend display to the left or to the right.



To exit a *Trend* view, press the **Home** button.

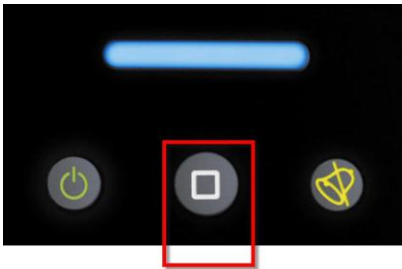

Changing the Time Interval of Trend Data

Users can change the time interval of trend data. The time options that can be selected are 10 minutes, 30 minutes, 1 hour, 2 hours, 4 hours, 8 hours, 12 hours, or 24 hours.

To change the time interval of trend data

1. From the *Display View*, in the *Trend Field*, or from the the *Full Trend* screen, touch the *Time Interval* icon.



2. Scroll up or down to select a time interval.



Using the Histogram Feature

Users can view trend data using the Histogram feature. When turned on, the Histogram feature displays trend data as a histogram.

To turn on the Histogram feature

1. Navigate to a *Full Trend* screen. See **Changing Between Trend Views** on page 78.
2. The Histogram icon appears along the top of the *Trend Field*, as shown in the following example for SpO2.



3. Touch the *Histogram* icon.
4. Trend data displays as a histogram.

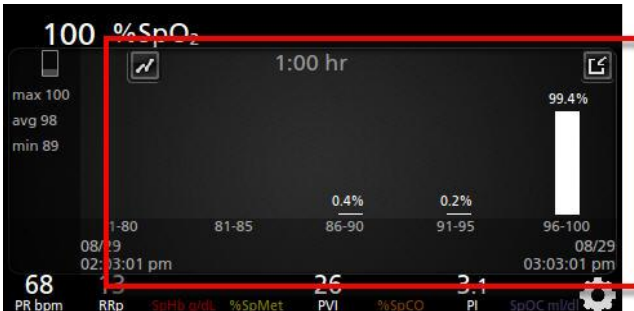

To turn off the Histogram feature

- Touch the *Trends* icon, as shown.

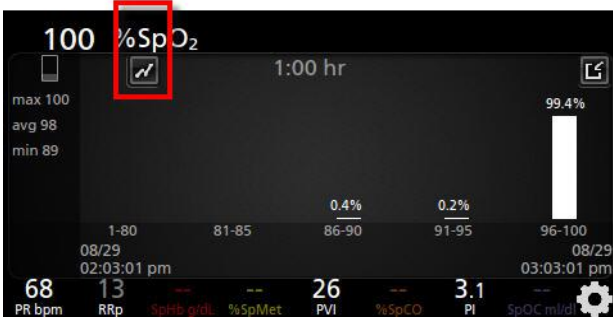

Changing Trend Settings

There are several ways to access and then change the maximum value and the minimum value of the Y axis for any of the available parameters.

To access the trend settings for any of the available parameters

1. From the *Main Menu* screen, touch the *Trends* icon.
2. From the *Trends* screen, touch any of the available parameters.



Alternatively, from any *Parameter Settings* screen, touch the *Trends* icon.



Alternatively, from the *Display View* or from the *Full Trend* view, touch the Y axis range on the left side of the screen as shown. When viewing trends for an additional parameter, the Y axis range appears on the right side of the screen.



To change the trend settings for any of the available parameters

1. Touch the slider for the Y-axis maximum or the Y-axis minimum. The following is an example of the *SpO2 Trend* screen.



2. Select the desired setting by scrolling up or down.



3. When finished, select **OK**.

Deleting Trend Data

The user can delete patient trend data that has been stored on the Radical-7.

To delete patient trend data

1. From the *Trends* screen, touch the *Trend Settings* icon.



2. From the *Trend Settings* screen, touch **Clear**, and then touch **OK**. This deletes all stored trend data.

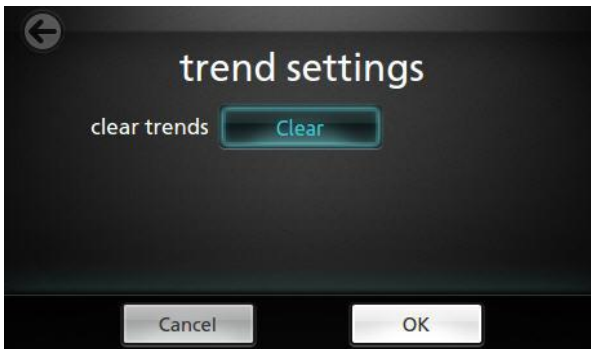

About



For information about parameters, see **About Parameter Information** on page 60.

From the *About* screen, view any of the following options:

Options	Description
Serial Number	Displays the serial number of the Handheld.
MCU	Displays the version number of the instrument board software.
MX Board	Displays the version number of the technology level software.
Processor	Displays the version number of the system level software.
Docking Station	If docked, displays the current software version of the Docking Station.

Chapter 5: Profiles



The Radical-7 can be configured for various patient types.

Profiles Overview

The Radical-7 contains a *Profiles* screen, which lets the user customize different settings for different patient populations:

- **Adult**
Adult profile is the factory default profile. Displays in the Status bar as *ADULT* and the color of the Profile button turns blue.
- **Neonatal**
Displays in the Status bar as *NEO* and the color of the Profile button turns pink.
- **Custom**
Displays in the Status bar as *CUSTOM* and the Profile button is not illuminated and appears gray.

If no changes are made to settings, then after a power cycle, the Radical-7 automatically resets to the *Adult* profile because *Adult* is the factory default profile.

If the Profile setting is changed to *NEO* or *CUSTOM*, then after a power cycle, the Radical-7 remembers the previously selected Profile setting.

The active profile displays in the Status Bar. In the following example, the *Adult* profile is active.

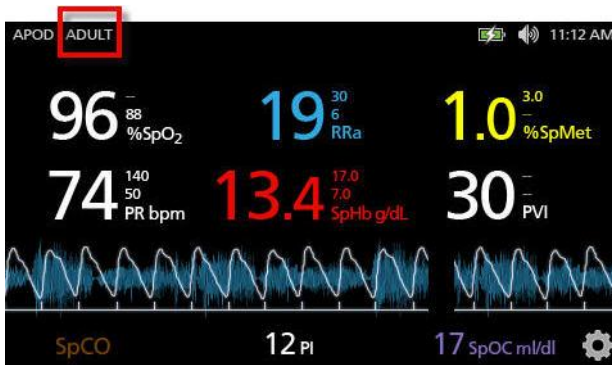

The Radical-7 conveys the active profile by changing the color of the *Profiles* button.

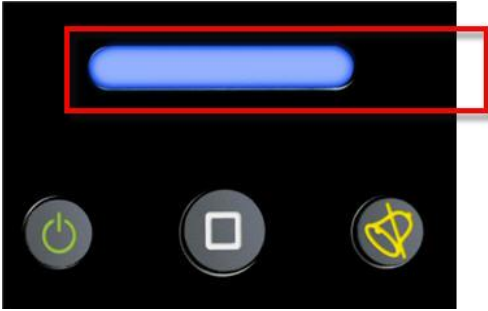

To restore all Radical-7 settings to factory default settings, see **Access Control** on page 72.

Changing Profiles

Changing Profiles is done in the *Profiles Settings* screen. There are different ways to access the *Profiles Settings* screen.

- The first way is by touching the *Profiles* shortcut in the Status Bar, as show below.



- Another way to access the *Profiles Settings* screen is by pressing the *Profile* button, as shown below.

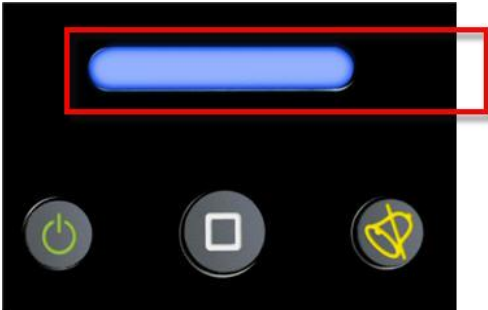

- Alternatively, from the *Main Menu* screen, touch the *Profiles* icon.



To change Patient Type

1. From the Profile screen, touch the *Patient Type* field.

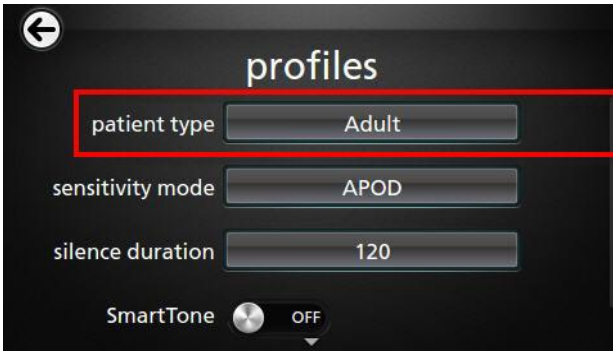

2. Select the desired Patient Type by scrolling up or down.

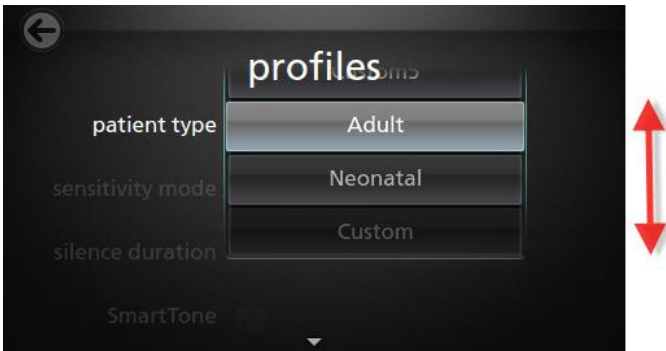

3. When finished, touch **OK**. To confirm selection, check the Status Bar.

From the *Profiles* screen, change any of the following options:

Options	Description	Factory Default Settings	User Configurable Settings
Patient Type	Defines the patient population for which the device will operate.	Adult	Neonatal, Adult, Custom, or Custom 1 to 5
Sensitivity Modes	Defines the sensitivity level for which the device will operate. See <i>Sensitivity Modes Overview</i> on page 55.	APOD	MAX, APOD, or NORM

Silence Duration	The amount of time for which the audible part of an alarm will be silenced. See Silencing the Alarms on page 95.	120	30, 60, 90, 120 seconds
Smart Tone	Allows the audible pulse to continue to beep when the pleth graph shows signs of motion.	Off	On or Off

Replacing Factory Default Settings for Adult and Neo Profiles

The *Adult* profile and the *Neonatal* profile can be modified to meet specific requirements and then they can replace the factory default settings for *Adult* and *Neonatal* profiles. As such, after a power cycle, the Radical-7 remembers the preferred settings for *Adult* and *Neonatal* instead of the factory default settings. When preferred settings for *Adult* and *Neonatal* are saved instead of the factory default settings, the Profile button changes to same blue or pink color. See **Profiles Overview** on page 89.

A user can also load preferred profile configurations into the Radical-7 using a separate tool.

To change the factory default settings for Adult or Neonatal profile settings

1. Make the preferred changes to any of the Radical-7 settings.
2. Navigate to the **Access Control** screen. See **Access Control** on page 72.
3. For either Adult or Neonatal, touch **Save**.

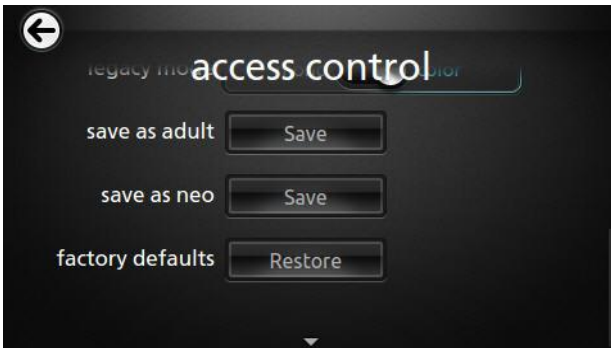

4. Touch **Ok**.
5. Alternatively, the user can restore all *Profile* settings to their factory default values by touching **Restore**, and then touching **Ok**.
6. Confirm the changes by powering off and powering on the Radical-7 and then verifying settings.

Powering Off the Radical-7

When turning off the Radical-7, the device remembers the preferred settings.

To turn off the Radical-7

1. Press and hold the button for more than 2 seconds.

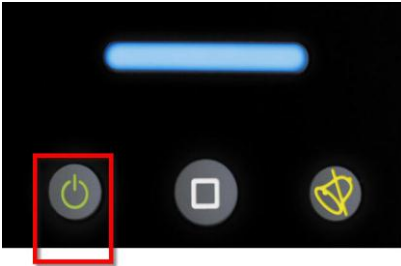

2. To confirm the shutdown process, the following screen appears.



Chapter 6: Alarms and Messages

The following chapter contains information about alarms and messages.

For more information, see **Chapter 7: Troubleshooting** on page 105.

About Alarms

The Radical-7 visually and audibly indicates alarm conditions that the system detects. Audible alarms may be silenced, without affecting the operation of visual alarms. See **Safety Information, Warnings, and Cautions** on page 11 and **Alarm Related Safety Information, Warnings, and Cautions** on page 19.

There are three priorities for alarms:

- High
- Medium
- Low

Alarm Delay

When an alarm condition is met, this feature delays the audible part of an alarm.

Silencing the Alarms

Alarms are conveyed in ways: audible, visual, or both.

The following is an example of a visual alarm for an exception message:

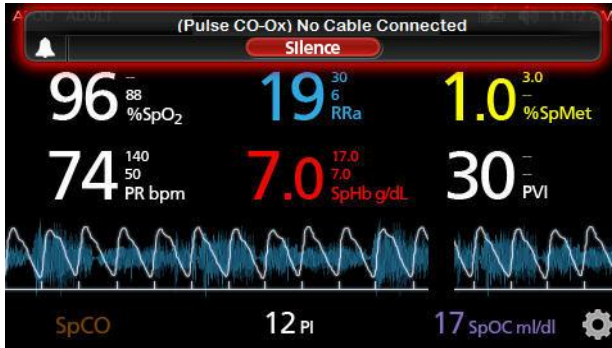

The following is an example of a typical alarm due to parameter limit violation.



To silence or dismiss alarms:

- Touch **Silence** (the highlighted area of the Status Bar).

Audible alarms can be temporarily suspended by pressing the *Alarm Silence* button. When alarms are in the *suspend state*, pressing the *Alarm Silence* button cancels the alarm suspend.

To silence audible alarms

1. When an audible is active, push **Alarm Silence** one time.



2. The audible alarm is silenced for up to 120 seconds and a countdown timer displays.



3. The length of time for which an audible alarm remains silenced (suspended) can be changed using the Silence Duration feature located on the *Sounds* screen. See *Sounds* on page 70.

3D Alarms



3D Alarms include the Desat Index Alarm and the PI Delta Alarm.

Desat Index Alarm Overview on page 97.

Perfusion Index (PI) Delta Alarm Overview on page 98.

Desat Index Alarm Overview

The Desat Index Alarm is a user-selectable feature which allows a clinician to request an audible and visual alarm if a patient experiences a specified number of desaturations over a specific period of time.

Traditional high and low SpO₂ alarm limits alert clinicians to saturation levels that exceed user selected thresholds, and these thresholds are typically established at a considerable change from the patients' baseline saturation level. However, in select patient populations, substantial desaturation events that exceed a typical low alarm limit threshold may be preceded by a cycle of transient desaturations over a limited timeframe, and the ability to alert clinicians to a cycle of these smaller desaturations may provide an earlier indication of a potential significant decline in the patient's status and the need for more focused monitoring and/or a change in treatment.

To address patient populations at risk for cyclic, moderate desaturations, the option includes a user-selectable Desat Index Alarm which allows the clinician to request an audible and visual alarm in the event the patient experiences a specified number of desaturations beyond a defined level from the patient's baseline saturation over a specific window of time, with each of these variables selectable by the user within established ranges as noted in ***Desat Index Settings*** on page 97.

Desat Index Settings

From the *Desat Index Settings* screen, access the following screens:

Desat Index Alarms on page 98.

About Parameter Information on page 60.

Desat Index Alarms

From the *Alarms* screen, change any of the following options:

Options	Description	Factory Default Settings	User Configurable Settings
Delta	See Desat Index Alarm Overview on page 97.	4%	2% to 10% in steps of 1%.
Time	See Desat Index Alarm Overview on page 97.	1 hour	1 to 4 hours, in steps of 1.
# of Events	See Desat Index Alarm Overview on page 97.	Off	Off, 1 to 24 desaturations in steps of 1.

Perfusion Index (PI) Delta Alarm Overview

The PI Delta Alarm is a user-selectable feature which allows a clinician to request an audible and visual alarm if perfusion at the monitored site decreases by a specified level (delta) over a specific period of time.

Perfusion Index gives an indication of the level of perfusion at the monitored site. The Radical-7 measures perfusion at the SpO₂ site by comparing the pulsatile signal to the non-pulsatile signal, and expressing that ratio as a percentage. PI has been clinically proven to be useful as a predictor of the level of illness in neonates and adults and that PI may change dramatically in response to sympathetic changes caused by inhalational agents and pain stimulation*. If PI decreases over time, there may be underlying physiological reasons that may need to be addressed.

The PI Delta provides an audible and visual alert to important changes in perfusion compared to the patient's baseline PI rate. The baseline is set by the Radical-7 once the user has enabled the alarm. The baseline is 30 seconds of currently averaged PI. The feature includes a user-selectable PI Delta Alarm. This allows the clinician to request an audible and visual alarm if perfusion at the monitored site decreases by a specified level (delta) over a specified window of time. Three of the variables are selectable by the user within established ranges as noted in **PI Delta Settings** on page 98.

**De Felice C, Latini G, Vacca P, Kopotic RJ. The pulse oximeter perfusion index as a predictor for high illness severity in neonates. Eur J Pediatr. 2002; 161:561-562.*

PI Delta Settings

From the *PI Delta Settings* screen, access the following screens:

Perfusion Index (PI) Delta Alarm Overview on page 98.

About Parameter Information on page 60.

PI Delta Alarms

From the *Alarms* screen, change any of the following options:

Options	Description	Factory Default Settings	User Configurable Settings
Set Baseline	See <i>Perfusion Index (PI) Delta Alarm Overview</i> on page 98.	Off	On or Off
Baseline	See <i>Perfusion Index (PI) Delta Alarm Overview</i> on page 98.	Off, or PI baseline	N/A
Percent Change	See <i>Perfusion Index (PI) Delta Alarm Overview</i> on page 98.	50%	10% to 99% in steps of 1%
Timeout	See <i>Perfusion Index (PI) Delta Alarm Overview</i> on page 98.	None	1 min, 5 min, 30 min, 1 hr, 4 hr, 8 hr, 12 hr, 24 hr, 36 hr, 48 hr, or None.

Messages

The following section lists common messages, their potential causes, and next steps.

Replace Sensor Message

Message:

- *(Pulse CO-Ox) Replace Sensor, or*
- *(RAM) Replace Sensor*

SpHb reusable sensor has used all its available monitoring time. Sensor is non-functional. Defective sensor.

Next steps: Replace sensor.

Replace Cable Message

Message:

- *(Pulse CO-Ox) Replace Cable, or*
- *(RAM) Replace Cable*

The patient cable is non-functional or the life of the cable has expired.

Next steps: Replace the patient cable.

Replace Adhesive Sensor Message

Message:

- *(Pulse CO-Ox) Replace Adhesive Sensor, or*
- *(RAM) Replace Adhesive Sensor*

When a single-patient-use sensor is used, the adhesive portion of the sensor is non-functional, or the life of the adhesive portion of the sensor has expired. (Applies to Rainbow ReSposable CO-Oximeter Sensor Systems or ReSposable Pulse Oximeter Sensor Systems only.)

Next steps: Replace the adhesive portion of the sensor.

Incompatible Sensor Message

Message:

- *(Pulse CO-Ox) Incompatible Sensor, or*
- *(RAM) Incompatible Sensor*

Not a proper Masimo sensor.

Next steps: Replace with a proper Masimo sensor.

SpHb sensor is attached to a instrument without SpHb installed.

Next steps: Use a non-SpHb sensor. Contact your local Masimo Representative to learn more about the optional SpHb upgrade.

Incompatible Adhesive Sensor Message

Message:

- *(Pulse CO-Ox) Incompatible Adhesive Sensor, or*
- *(RAM) Incompatible Adhesive Sensor*

Not a proper Masimo sensor.

Next steps: Replace with a proper Masimo sensor.

SpHb sensor is attached to a instrument without SpHb installed.

Next steps: Use a non-SpHb sensor. Contact your local Masimo Representative to learn more about the optional SpHb upgrade.

No Adhesive Sensor Connected Message

Message:

- *(Pulse CO-Ox) No Adhesive Sensor Connected, or*
- *(RAM) No Adhesive Sensor Connected*

When a single-patient-use sensor is used, the adhesive portion of the sensor is not connected. (Applies to Rainbow ReSposable CO-Oximeter Sensor Systems or ReSposable Pulse CO-Oximeter Sensor Systems only.)

Next steps: Ensure the adhesive portion is firmly connected to the sensor.

Interference Detected Message

Message:

- *(Pulse CO-Ox) Interference Detected, or*
- *(RAM) Interference Detected*

High intensity light such as pulsating strobe lights, excessive ambient light sources such as surgical lights or direct sunlight, or other monitor displays.

Next steps: Place a Masimo Optical Light Shield over the sensor.

Incorrect monitor line frequency setting (Hz).

Next steps: . Adjust the Line Frequency to the correct Hz setting. See **Device Settings** on page 71.

SpO2 Only Mode Message

Message: *(Pulse CO-Ox) SpO2 Only Mode*

Occurs during an unsuccessful sensor initialization/pulse search routine or during monitoring.

Next steps: See the directions for use provided with your sensor. Use a Masimo light shield to cover the sensor and adjust the sensor.

Low Battery Message

Battery charge is low.

Next steps: Charge battery by placing the Handheld into the Docking Station and powering the instrument with AC line power. Replace battery if necessary.

Low Perfusion Index Message

Message: *(Pulse CO-Ox) Low Perfusion Index*

Signal too small.

Next steps: Move sensor to better perfused site. See **Low Perfusion** on page 106.

Low Signal IQ Message

Message: *(Pulse CO-Ox) Low Signal IQ*

Low signal quality.

Next steps: Ensure proper sensor application. Move sensor to a better perfused site. See **Signal IQ (SIQ)** on page 105.

Low SpCO SIQ Message

SpCO measurement reading is obscured.

Next steps: Ensure proper sensor application. Check sensor to see if it is working properly. If not, replace the sensor. See **Successful Monitoring for SpCO** on page 28.

Low SpMet SIQ Message

SpMet measurement reading is obscured.

Next steps: Ensure proper sensor application. Check sensor to see if it is working properly. If not, replace the sensor. See **Successful Monitoring for SpCO** on page 28.

Low SpHb SIQ Message

SpHb measurement reading is obscured.

Next steps: Ensure proper sensor application. Check sensor to see if it is working properly. If not, replace the sensor. See **Successful Monitoring for SpHb** on page 27.

Speaker Failure Message

Instrument requires service. **Next steps:** Contact Masimo Tech Support. **Chapter 9: Service and Maintenance** on page 123.

No Cable Connected Message

Message:

- *(Pulse CO-Ox) No Cable Connected, or*
- *(RAM) No Cable Connected*

Cable not attached or not fully inserted into the connector.

Next steps: Disconnect and reconnect cable into connector.

No Sensor Connected Message

Message:

- *(Pulse CO-Ox) No Sensor Connected, or*
- *(RAM) No Sensor Connected*

Sensor not fully inserted into the connector. May be an incorrect sensor or a defective sensor or cable.

Next steps: Disconnect and reconnect sensor. See the instructions for use provided with your sensor.

Instrument is searching for patient's pulse.

Next steps: Disconnect and reconnect the sensor into the Patient Cable connector.

Sensor is disconnected from patient cable. Sensor connected upside down into patient cable.

Next steps: Check to see if the sensor LED is flashing. Disconnect and reconnect the sensor. If the LED fails to operate, replace the sensor.

Pulse Search Message

Message: *(Pulse CO-Ox) Pulse Search*

Instrument is searching for pulse.

Next steps: If instrument fails to display within 30 seconds, disconnect and reconnect. If pulse search continues, move sensor to better perfused site.

Sensor Initializing Message

Message: *(Pulse CO-Ox) Sensor Initializing*

Instrument is checking the sensor for proper functioning and performance.

Next steps: If values are not displayed within 30 seconds, disconnect and reconnect sensor. If values are still not displayed, replace with a new sensor.

Sensor Off Patient Message

Message:

- *(Pulse CO-Ox) Sensor Off Patient, or*
- *(RAM) Sensor Off Patient*

Sensor off patient.

Next steps: Disconnect and reconnect sensor. Reattach sensor.

Sensor not connected to patient properly. Sensor is damaged.

Next steps: Properly reapply the sensor on the patient and reconnect the sensor to the instrument or patient cable. If the sensor is damaged, replace the sensor.

Service Required Message

Internal Failure. Instrument requires service. The message fills the entire display. This is a numeric error code.

Next steps: Contact Masimo for service, see **Chapter 9: Service and Maintenance** on page 123.

Incompatible Cable Message

Message: *(Pulse CO-Ox) Incompatible Cable*

Not a proper cable.

Next steps: Replace with a proper cable.

Chapter 7: Troubleshooting

The following chapter contains information about troubleshooting the Radical-7 system.

Troubleshooting Measurements

See *Parameter Related Safety Information, Warnings, and Cautions* on page 11.

Signal IQ (SIQ)

The Signal IQ provides an indicator of the assessment of the confidence in the displayed SpO₂ value. The SpO₂ SIQ can be also used to identify the occurrence of a patient's pulse.

With motion, the plethysmographic waveform is often distorted and may be obscured by artifact. Shown as a vertical line, the SpO₂ SIQ coincides with the peak of an arterial pulsation. Even with a plethysmographic waveform obscured by artifact, the Signal IQ identifies the timing that the algorithms have determined for the arterial pulsation. The pulse tone (when enabled) coincides with the vertical line of the SpO₂ SIQ.

The height of the vertical line of the SpO₂ SIQ provides an assessment of the confidence in the measurement displayed. A high vertical bar indicates higher confidence in the measurement. A small vertical bar indicates lower confidence in the displayed measurement. When the Signal IQ is very low, this suggests that the accuracy of the displayed measurement may be compromised. See *About the Status Bar* on page 49.

When parameters are dimly lit, proceed with caution and do the following:

- Assess the patient.
- Check the sensor and ensure proper sensor application. The sensor must be well secured to the site for the Radical-7 Pulse CO-Oximeter to maintain accurate readings. Misalignment of the sensor's emitter and detector can result in smaller signals and cause erroneous readings.
- Determine if an extreme change in the patient's physiology and blood flow at the monitoring site occurred, (e.g. an inflated blood pressure cuff, a squeezing motion, sampling of an arterial blood specimen from the hand containing the pulse oximetry sensor, severe hypotension, peripheral vasoconstriction in response to hypothermia, medications, or an episode of Raynaud's syndrome.)
- With neonates or infants, check that the peripheral blood flow to the sensor site is not interrupted. Interruption, for example, may occur while lifting or crossing their legs during a diaper change.
- After performing the above, if the parameter remains dimly lit frequently or continuously, obtaining an arterial blood specimen for CO-Oximetry analysis may be considered to verify the oxygen saturation value.

See *Parameter Related Safety Information, Warnings, and Cautions* on page 11.

Dimly Lit Parameters

When the signal quality is very low, the accuracy of measurements may be compromised, the parameter may be dimly lit, and the parameter may display dashes instead of a numeric value.

Low Perfusion

It has been suggested that at extremely low perfusion levels, pulse oximeters can measure peripheral saturation, which may differ from central arterial saturation. This "localized hypoxemia" may result from the metabolic demands of other tissues extracting oxygen proximal to the monitoring site under conditions of sustained peripheral hypoperfusion. This may occur even with a pulse rate that correlates with the ECG heart rate.

Low Signal Quality

Improper sensor type or application.

Next steps: Excessive motion relative to perfusion. Sensor is damaged or not functioning. Check and see if blood flow to the site is restricted. Check the placement of the sensor. Reapply sensor or move to a different site. See **Appendix: Best Practices for Comparisons to Reference Measurements** on page 131.

SpO₂ Values Do Not Correlate With Clinical Assessment or Arterial Blood Gas Measurements

Low perfusion or sensor displacement.

Next steps: Check for error messages. See **Chapter 6: Alarms and Messages** on page 95. Check placement of sensor or if it is too tight. Reapply sensor or select a new site. Set to MAX sensitivity and confirm that the sensor is securely on the patient. See the directions for use provided with your sensor.

Unexpected SpO₂, SpCO, SpMet, or SpHb Reading

- Low SIQ or PI values.
Next steps: Reposition sensor to site with strong SIQ and PI. Average readings taken from three different sites to improve accuracy. Submit blood sample for laboratory CO-Oximetry test for comparison.
- Inappropriate sensor size or sensor measurement location.
Next steps: Verify proper sensor for patient size. Verify proper sensor site. See **Appendix: Best Practices for Comparisons to Reference Measurements** on page 131.

Unexpectedly High SpCO Reading

Possible elevated methemoglobin level.

Next steps: Submit blood sample for laboratory CO-Oximetry test. See **Appendix: Best Practices for Comparisons to Reference Measurements** on page 131.

Difficulty Obtaining a Reading

- Low battery/ not plugged into AC power supply.
Next steps: Insert Handheld into Docking Station, verify Docking Station power cord plugged in and Docking Station power indicator light is illuminated.
- Interference from line frequency induced noise.
Next steps: Verify/set 50/60hz menu setting. See **Localization** on page 74.
- Inappropriate sensor or sensor size.
Next steps: Verify proper sensor and sensor size for the patient.
- Excessive ambient or strobing light.
Next steps: Shield the sensor from excessive or strobing light. Minimize or eliminate motion at the monitoring site. See **Appendix: Best Practices for Comparisons to Reference Measurements** on page 131.

SpCO Reading Displays as Dashes

- SpO2 value below 90% **Next steps:** Assess/address patient condition.
- SpMet value greater than 2% **Next steps:** Laboratory analysis of a blood sample should be performed.
- SpCO parameter has not yet stabilized during initial startup
Next steps: Verify proper sensor and sensor size for the patient. Allow time for parameter reading to stabilize. See **Appendix: Best Practices for Comparisons to Reference Measurements** on page 131.

Troubleshooting the Radical-7

For more information, see **Chapter 6: Alarms and Messages** on page 95.

Instrument Does Not Turn On

One or both of the fuses are not operating properly.

Next steps: Replace the fuses. For details, see **Replacing the Fuses** on page 125.

Instrument Turns On But Screen is Blank

The viewing contrast is not correct.

Next steps: Adjust the brightness setting. See **Brightness** on page 76. If the condition persists, requires service. See **Contacting Masimo** on page 129.

Continuous Speaker Tone

Internal failure.

Next steps: To silence an alarm, press the *Alarm Silence* button. If alarm continues to sound, turn off the Radical-7. If necessary, remove Handheld battery. Requires service. See **Contacting Masimo** on page 129.

Buttons Do Not Work When Pressed

Internal failure.

Next steps: Requires service. See **Contacting Masimo** on page 129.

Handheld Battery Does Not Charge

AC power cable may be disconnected.

Next steps: Restore power to the instrument.

Battery Run Time Significantly Reduced

Battery memory effects. **Next steps:** See **Battery Operation and Maintenance** on page 123.

Indicators on Docking Station Continuously Flash

Incompatible version of software on Handheld and Docking Station.

Next steps: Upgrade to current software versions. Match Handheld to Docking Station with compatible software versions.

Chapter 8: Specifications

The following chapter contains specifications for the Radical-7 Handheld, compatible Docking Stations, and the Standalone system.

Measurement Range

Measurement	Display Range
SpO ₂ (Oxygen Saturation)	0% to 100%
SpMet (Methemoglobin)	0% to 99.9%
SpCO (Carboxyhemoglobin)	0% to 99%
SpHb (Hemoglobin)	0 g/dL to 25.0 g/dL
SpOC (Oxygen Content)	0 ml of O ₂ /dL to 35 ml of O ₂ /dL of blood
PR (Pulse Rate)	25 bpm to 240 bpm
PI (Perfusion Index)	0.02% to 20%
PVI (Pleth Variability Index)	0% to 100%
RRa (Respiration Rate)	0 breaths per minute to 70 breaths per minute

Accuracy

Oxygen Saturation Accuracy [1]	
No Motion	60% to 80%
Adults, Infants, Pediatrics	±3%
No Motion [2]	70% to 100%
Adults, Infants, Pediatrics	± 2%

Neonates	$\pm 3\%$
Motion [3]	70% to 100%
Adults, Infants, Pediatrics, Neonates	$\pm 3\%$
Low Perfusion [4]	
Adults, Infants, Pediatrics, Neonates	$\pm 2\%$
Pulse Rate Accuracy	
Pulse rate range	25 bpm to 240 bpm
No Motion	
Adults, infants, pediatrics, neonates	± 3 bpm
Motion [4]	
Adults, infants, pediatrics, neonates	± 5 bpm
Low Perfusion	
Adults, infants, pediatrics, neonates	± 3 bpm
Carboxyhemoglobin Accuracy [1]	
Adults, infants, pediatrics	1% to 40% $\pm 3\%$
Methemoglobin Saturation Accuracy [1]	
Adults, infants, pediatrics, neonates	1% to 15% $\pm 1\%$
Total Hemoglobin Accuracy [6]	
Adults, pediatrics	8 g/dL to 17 g/dL ± 1 g/dL
Respiratory Rate Accuracy (RRa) [11]	
Adults, pediatrics	4 breaths per minute to 69 breaths per minute, ± 1 breath per minute

Resolution

Parameter	Step Size
%SpO ₂	1%
%SpCO	1%
%SpMet	0.1%
SpHb g/dL	0.1 g/dL
Pulse Rate	1 beats per minute
Respiration Rate	1 breath per minute

Electrical

Standalone	
AC Power requirements	100 to 240 VAC, 47 to 63 Hz
Power consumption	55 VA
Fuses	1 Amp, Fast Acting, Metric, (5x20mm), 250V
Handheld Battery	
Type	Lithium ion
Capacity	4 hours [7]
Time	3 hours

Environmental

Operating Temperature	32°F to 122°F (0°C to 50°C)
Transport/Storage Temperature	-40°F to 158°F (-40°C to 70°C) [8]

Operating Humidity	10% to 95%, non-condensing
Operating Altitude	500 mbar to 1060 mbar -1000 ft to 18,000 ft (-304 m to 5,486 m)

Physical Characteristics

Dimensions	
Handheld	8.9" x 3.5" x 2.1" (22.6 cm x 8.9cm x 5.3 cm)
Standalone	3.5" x 10.5" x 7.7" (8.9 cm x 26.7 cm x 19.6 cm)
Weight	
Handheld	1.2 lbs. (0.54 kg)
Docking Station (RDS-1, RDS-2, RDS-3)	2.5 lbs. (1.14 kg)
Standalone (RDS-1, RDS-2, RDS-3)	3.8 lbs. (1.73 kg)

Trending

<ul style="list-style-type: none"> Max of 96 hours of trending at 2-second resolution 	
Sensitivity	NORM, MAX, and APOD [10]

Alarms

Parameter	Alarm Range
SpO ₂	1% to 99%
SpCO	1% to 98%
SpMet	0.1% to 99.5%
SpHb	1.0 g/dL to 24.5 g/dL

RR	5 breaths per minute to 69 breaths per minute
PI	0.03% to 19%
PVI	1% to 99%
Pulse Rate	30 bpm to 235 bpm
SpOC	1 g/dL to 34 g/dL
Sensor condition, system failure, and low battery alarms	
High Priority	571 Hz tone, 5-pulse burst, pulse spacing: 0.250s, 0.250s, 0.500s, 0.250s, repeat time: 10s
Medium Priority	550 Hz tone, 3-pulse burst, pulse spacing: 0.375s, 0.375s, repeat time: 7s
Low Priority	500 Hz tone, 1-pulse burst, repeat time: 5s
Alarm Muted Reminder	500Hz tone, 2-pulse burst, pulse spacing 0.375s, repeat time: 3 min
Alarm Volume	High Priority: 70 dB (min) Medium Priority: 70 dB (min) Low Priority: 45 dB (min)

Display Indicators

Display Update Rate	1 second
Response Time	< 20 second delay
Type	Backlit Active Matrix TFT LCD
Pixels	480 dots x 272 dots
Dot Pitch	0.25 mm

Compliance

EMC Compliance	
<ul style="list-style-type: none"> • EN55011: Radiated Emissions (CISPR 11, 2009 Amendment A1:2010, Class B) • EN55011: Conducted Emissions (CISPR 11, 2009 Amendment A1:2010, Class B) • EN301 489-17: Radiated Emissions (EN 301 489-01 V1.8.1:2008, Class B) • EN301 489-17: Conducted Emissions (EN 301 489-01 V1.8.1:2008, Class B) • EN61000-3-2: Limitations of quasi-stationary current Harmonic Emissions (Requirements from EN 60601-1-2:2007) • EN301 489-17: Harmonic Emissions (EN 301 489-01 V1.8.1:2008) • EN61000-3-3: Limitations of voltage fluctuations and Flicker • EN301 489-17: Flicker (EN 301 489-01 V1.8.1:2008) • EN61000-4-2: ESD: Direct, Indirect, Vertical and Horizontal coupling plane • EN301 489-17: ESD: Direct, Indirect, Vertical and Horizontal coupling plane (EN 301 489-01 V1.8.1:2008) • EN61000-4-3: Radio Frequency Electromagnetic Field (80MHz to 2500MHz) at 3V/m, 2 Hz sine wave, 3 sec dwell • EN301 489-17: Radio Frequency Electromagnetic Field (80MHz to 2500MHz) at 3V/m (EN 301 489-01 V1.8.1:2008) • EN61000-4-4: Electric Fast Transient / Burst Immunity • EN301 489-17: Electrical Fast Transient / Burst Immunity • EN61000-4-5: Surge Immunity • EN301 489-17: Surge Immunity • EN61000-4-6: Conducted Immunity, Disturbances induced by RF Fields (150 KHz to 80 MHz) • EN301 489-17: Conducted Immunity , Disturbances induced by RF Fields • EN61000-4-8: Power Frequency Magnetic Field Immunity • EN301 489-17: Voltage dips and interruptions • EN61000-4-11: AC voltage dips • EN61000-4-11: AC voltage interruptions 	
Equipment Classification	<ul style="list-style-type: none"> • IEC 60601-1 / UL 60601-1 • EN60601-1: 1990 + A1: 1993 + A2: 1995
Type of Protection	Class 1 (on AC power), Internally powered (on battery power)

Degree of Protection-Patient Cable	Type BF-Applied Part
Degree of Protection-SatShare Cable	Type CF-Applied Part
Mode of Operation	Continuous

Output Interface

SatShare (RDS-1). See Serial Interface Specifications on page 115.
Serial RS-232 (RDS-1, RDS-3)
Nurse Call/Analog Output (RDS-1, RDS-3)
VueLink, (Philips, Agilent, HP, Spacelabs Flexport, RadNet, SafetyNet (RDS-1, RDS-3)

Wireless Radio (If Installed)

Radio Modes	802.11 a/b/g
Encryption	64/128-bit WEP, Dynamic WEP, WPA-TKIP, WPA2-AES
Authentication	Open System, Shared Key, Pre-Shared Key (PSK), 802.1X: LEAP, PEAP< TTLS, TLS, EAP-FAST
Compliance	
USA	FCC ID: VKF-RAD7CA, FCC parts 15.207, 15.209, 15.247, and 15.407
Canada	IC: 7362A-RAD7CA RSS-210
Europe	EN 3000 328, EN 301 893, EN 301 489-17

Serial Interface Specifications

The digital interface for serial communication is based on the standard RS-232 protocol. The Radical-7 by default always outputs ASCII 1 text data through the serial port, unless the

user selects a different output mode. To interface with the Radical-7 and receive serial text data, connect a serial interface cable with a ferrite bead installed to the serial output connector located on the back of the Radical-7 Docking Station. The Radical-7 serial interface is only available when the Radical-7 Handheld is properly attached to the Docking Station. Once serial communication is established, packets of data are communicated at 1 second intervals. See **Device Settings** on page 71.

Serial Interface Setup

To interface with the Radical-7 serial port, set the following communication parameters on the interfacing serial instrument:

Parameter	Setting
Baud rate	9600 baud bi-directional
Number of bits per character	8
Parity	None
Bits	1 start, 1 stop
Handshaking	None
Connector type	Female DB-9

The pin-outs for the RS-232 connector are shown in the following table:

Pin	Signal name
1	No Connection
2	Receive data – RS-232 ± 9 V (± 5 Vmin)
3	Transmit data – RS-232 ± 9 V (± 5 Vmin)
4	No Connection
5	Signal Ground Reference for COM signals
6	No Connection
7	No Connection

Pin	Signal name
8	No Connection
9	No Connection

Analog Output and Nurse Call Specifications

Analog Out and Nurse Call are accessible on the same female high-density DB-15 connector. Analog Output and Nurse Call interface are only available when the Handheld is attached to the Docking Station. Only use an Analog and Nurse Call cable that has a ferrite bead installed. Analog Output and Nurse Call interface is not available in all versions of the Docking Station. See **Nurse Call Test** on page 127 and **Handheld Front Panel** on page 35.

The following table shows the pin out of the Analog Output and Nurse Call.

Pin	Signal Name
1	+5V (60mA max.)
2	Ground
3	Ground
4	Ground
5	Ground
6	Nurse Call (Normally Open)
7	Nurse Call (Normally Closed)
8	Ground
9	Analog 1
10	Ground
11	Ground
12	Nurse Call -Common
13	Ground
14	Ground

Pin	Signal Name
15	Analog 2

Analog Output

The Radical-7 Pulse CO-Oximeter can interface with various analog recording instruments or strip chart recorders through its Analog Output connector located on the back of the Docking Station. The output signals vary from approximately 0 to 1 volt in a linear fashion. The actual analog output voltage generated may not exactly range between 0.0V to 1.0V. A variance of ± 40 mV is acceptable.

Calibration

For instrument calibration purposes, the analog output signals can be set to either 0 Volts or 1 Volt. Calibrate the analog recording system to those levels before use.









Nurse Call



The Nurse Call feature is available when the Radical-7 is operating as a standalone. Nurse Call is based on the relay closing or opening depending on alarm, Low Signal IQ events, or both. For maximum flexibility, either normally open (pin 6) or normally closed (pin 7) signals are available. Only qualified personnel should connect one of these two signals and common (pin 12) to a hospital's Nurse Call system. During an alarm condition or a Low Signal IQ event, depending on the configuration, the normally open pin will be connected to the common pin and the normally closed will be disconnected. The Nurse Call polarity can be inverted to accommodate various Nurse Call station requirements.

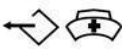

Parameter	Specification
Max voltage	100V DC or AC peak
Max Current	100mA





Symbols

The following symbols are found on the Radical-7, Docking Station, or packaging and are defined below. Some of the interfaces and symbols are not available on all versions of the Docking Station.

Symbols	Definition
 RS-232	RS-232 interface
	SatShare interface
	Equipotential ground terminal
	See Instructions for Use
	Fuse replacement
	Analog Out interface
	Nurse Call interface
	WEEE Compliant

Symbols	Definition
	Relative humidity storage range: 5% to 95%
	Storage temperature range: +70°C to -40°C; Storage altitude range: +1600hPa to +500hPa
	Keep dry
	Fragile/breakable, handle with care
	Year of Manufacture
IPX1	IPX1 Protection against liquid drops falling vertically
	Defibrillation proof type BF
EC REP	EU authorized representative

	Mark of conformity to European Medical Instrument Directive 93/42/EEC
Rx ONLY	Federal law restricts this device to sale by or on the order of a physician (USA FDA)
	Underwriter's Laboratories Inc. certification
	Non-ionizing electromagnetic radiation

	Caution
	Name of Manufacturer
	Wireless features can be used in member states with the restriction of indoor use in France
	Federal Communications Commission (FCC) licensing
IC Model	RAD7CA

Citations

[1] SpO₂, SpCO, and SpMet accuracy was determined by testing on healthy adult volunteers in the range 60% to 100% SpO₂, 0% to 40% SpCO, and 0% to 15% SpMet against a laboratory CO-Oximeter. SpO₂ and SpMet accuracy was determined on 16 neonatal NICU patients ranging in age from 7 days to 135 days old and weighting between 0.5 kgs and 4.25 kgs. Seventy-nine (79) data samples were collected over a range of 70% to 100% SaO₂ and 0.5% to 2.5% HbMet with a resultant accuracy of 2.9% SpO₂ and 0.9% SpMet. Contact Masimo for testing specifications.

[2] The Masimo Rainbow SET technology with Masimo sensors has been validated for no motion accuracy in human blood studies on healthy adult male and female volunteers with light to dark skin pigmentation in induced hypoxia studies in the range of 70-100% SpO₂ against a laboratory CO-Oximeter and ECG monitor. This variation equals plus or minus one standard deviation which encompasses 68% of the population weight.

[3] The Masimo Rainbow SET technology with Masimo sensors has been validated for motion accuracy in human blood studies on healthy adult male and female volunteers with light to dark skin pigmentation in induced hypoxia studies while performing rubbing and touching motions, at 2 to 4 Hz at an amplitude of 1 to 2 cm and a non-repetitive motion between 1 to 5 Hz at an amplitude of 2 to 3 cm in induced hypoxia studies in the range of 70-100% SpO₂ against a laboratory CO-Oximeter and ECG monitor. This variation equals plus or minus one standard deviation. Plus or minus one standard deviation encompasses 68% of the population.

[4] The Radical-7 has been validated for low perfusion accuracy in bench-top testing against a Biotek Index 2TM* simulator and Masimo's simulator with signal strengths of greater than 0.02% and transmission of greater than 5% for saturations ranging from 70-100%. This variation equals plus or minus one standard deviation. Plus or minus one standard deviation encompasses 68% of the population.

[5] Masimo Rainbow SET technology with Masimo sensors has been validated for pulse rate accuracy for the range of 25-240 bpm in bench top testing against a Biotek Index 2 simulator. This variation equals plus or minus one standard deviation which encompasses 68% of the population.

[6] SpHb accuracy has been validated on healthy adult male and female volunteers and on surgical patients with light to dark skin pigmentation in the range of 8 g/dL to 17 g/dL SpHb against a laboratory CO-Oximeter. The variation equals plus or minus one standard deviation which encompasses 68% of the population. The SpHb accuracy has not been validated with motion or low perfusion.

[7] This represents approximate run time at the lowest indicator brightness and pulse tone turned off using a fully charged battery.

[8] If the batteries are to be stored for extended periods of time, it is recommended that they be stored between -20°C to +30°C, and at a relative humidity less than 85%. If stored for a prolonged period at environmental conditions beyond these limits, overall battery capacity may be diminished, and lifetime of the batteries may be shortened.

[9] With FastSat the averaging time is dependent on the input signal. For the 2 and 4 second settings the averaging time may range from 2-4 and 4-6 seconds, respectively.

[10] Maximum sensitivity mode fixes perfusion limit to 0.02%.

[11] Respiration rate accuracy for the Masimo Acoustic Respiration Sensor and Instrument has been validated for the range of 4 to 70 breaths per minute in bench top testing. Clinical validation for up to 30 breaths per minute was also performed with the Masimo Acoustic Respiration Sensor and Instrument.

*Registered trademark of Fluke Biomedical Corporation, Everett, Washington.

Chapter 9: Service and Maintenance

The following chapter contains information about cleaning, battery operation, performance verification, service, repair, and warranty.

Cleaning

Under normal operation, no internal adjustment or recalibration is required. Safety tests and internal adjustments should be done by qualified personnel only. Safety checks should be performed at regular intervals or in accordance with local and governmental regulations. **Safety Information, Warnings, and Cautions** on page 11.

The Radical-7 Pulse CO-Oximeter is a reusable instrument. The instrument is supplied and used non-sterile.

To surface clean the Radical-7

- The outer surface of the instrument can be cleaned with a soft cloth dampened with a mild detergent and warm water solution.
- Do not allow liquids to enter the interior of the instrument.
- The outer surface of the instrument can also be wiped down using any of the following solvents:
 - Cidex Plus (3.4% glutaraldehyde)
 - 10% bleach solution
 - 70% isopropyl alcohol solution

Using the recommended cleaning solutions on the touchscreen panel will not affect the performance of the Handheld.

Battery Operation and Maintenance

The Radical-7 Handheld includes a lithium ion rechargeable battery. The Radical-7 Docking Station may include the optional 6.5 amp-hour nickel metal hydride rechargeable battery.

Before using the Radical-7 as a Handheld or as a transport monitor, the Handheld rechargeable battery and the optional Docking Station rechargeable battery must be fully charged.

To charge the Handheld rechargeable battery and the Docking Station rechargeable battery

1. Attach the Handheld to the Docking Station.
2. Connect the Docking Station to AC power.
3. Verify that the batteries are charging.
 - The Docking Station Battery Charging indicator momentarily flashes and then remains illuminated while the batteries are actively charging.
 - If the internal battery temperature exceeds recommended operating conditions for proper battery charging, the Handheld Battery Charging

indicator continuously flashes. When the temperature returns to recommended operating conditions, proper battery charging proceeds.

- The Handheld battery requires approximately 4 hours for charging. The Docking Station battery requires approximately 6 hours for charging.
- When both the Handheld Battery Charging indicator and the Docking Station Battery Charging indicator turn off, additional trickle charging may occur to complete charging.
- Memory effects of the battery may shorten run-time. When battery run time is significantly reduced, it is advisable to completely discharge and fully recharge the battery. Charging can occur while the Handheld is docked and turned on, the most efficient charge times are achieved when the Handheld is turned off.

During battery operation of the Radical-7, note that the following operating conditions affect the estimated run time of the included rechargeable batteries:

Estimated Run Times of Battery Power

The following tables outline the estimated run times of the battery-powered Radical-7. The time estimates are based on a Radical-7 with fully charged batteries. The time estimates are also based on a Radical-7 with and without the back-light illuminated.

The Radical-7 is always configured to include the Handheld battery. It may optionally be configured to include the Docking Station battery. Determine the configuration of the system before referencing the following tables.

Run Time for Handheld Only

In this configuration, the Radical-7 is configured to only include the Handheld battery (standard configuration). When running on battery power, it is advisable to operate only the Handheld. On battery power, it is possible to operate the Standalone (Handheld attached to the Docking Station with the Handheld battery providing power to the Docking Station). However, the capacity of the Handheld battery pack is not sufficient to support this mode for long periods of time.

For optimal battery run time, configure the device to automatically adjust the brightness. See **Brightness** on page 76.

Configuration	Operation Mode	Minimum run time
Handheld only	Handheld, undocked, not connected to AC power	4 hours
Handheld only	Handheld docked, not connected to AC power	1 hour

Replacing the Batteries

Before installing or removing the battery, make sure the AC power cord is removed and power to the Radical-7 is turned off.

To replace the rechargeable Handheld battery

1. Turn off the Radical-7 Handheld off and remove the patient cable connection. If docked, detach the Handheld from the Docking Station.
2. Loosen the closure screw on the battery compartment door and lift out the battery.
3. Take a new battery and place it in the compartment.
4. Tighten the closure screw.
5. Place the Handheld into Docking Station, turn on line power and charge battery.

See **Battery Operation and Maintenance** on page 123.

Replacing the Fuses

Should a power problem blow one or both of the fuses in the power entry module on the rear panel, the fuse(s) will need to be replaced. Before starting, the user will need a 5-mm or 3/16-in screwdriver.

To replace the fuse(s)

1. Disconnect instrument from AC power.
2. Remove AC power cord from the power entry module at the rear of the Docking Station.
3. Using the screwdriver, gently pry loose the fuse cover in the left portion of the power entry module, exposing the fuse holder.
4. Using the screwdriver, gently remove the fuse holder.
5. Note how the fuse(s) are placed in the fuse holder for installation of the new fuse(s).
6. To remove the fuses from the fuse holder, use the edge of the screwdriver blade to pry against the bottom of the metal portion of the fuse where it is secured to the glass portion of the fuse.
7. Place the fuse(s) (1 amp, metric, fast-acting, 5x20mm, 250V) in the fuse holder, properly orienting the fuse(s).
8. Slide the fuse holder back into the power entry module and press firmly to make sure it is completely seated.
9. Close the fuse cover and press gently until it seats completely, flush with the back of the Docking Station.
The instrument is ready to be reconnected to AC power. If the fuses blow shortly after replacement, the instrument requires service.

Performance Verification

Under normal operation, no internal adjustment or recalibration is required. Safety tests and internal adjustments should be done by qualified personnel only. Safety checks should be performed at regular intervals or in accordance with local and governmental regulations.

To test the performance of the Radical-7 following repairs or during routine maintenance, follow the procedure outlined in this chapter. If the Radical-7 fails any of the described tests, discontinue its use and correct the problem before returning the instrument back to the user.

Before performing the following tests, do the following:

- Place the Handheld into the Docking Station.
- Connect the Docking Station to AC power and fully charge the Handheld battery.
- Disconnect any patient cables or pulse oximetry probes.
- Disconnect any SatShare, serial or analog output cables from the instrument.
- Set the Radical-7 to Normal operating mode by going to the Main menu and the Home Use feature to *No*.

Power-On Self Test

To conduct a Power-On Self Test

1. Connect the monitor to the AC power and verify that the AC Power indicator is illuminated.
2. Turn on the monitor. Within 5 seconds, all available indicators illuminate, the instrument emits a tone and the Masimo logo displays.
3. The Docking Station indicator continuously illuminates and the Radical-7 begins normal operation.

Alarm Limit Test

To conduct an Alarm Limit Test

1. Change the High SpO2 Alarm parameter to a value two points below the currently selected value. See Alarms for SpO2.
2. Verify that the newly set parameter is shown on the *Display* screen.
3. Return the parameter to its original setting.
4. Repeat steps 1 to 3 for all active parameters.
5. Reset the alarm limits again to the original settings.

Testing with the optional Masimo SET Tester

To conduct a test with the optional Masimo SET Tester

1. Turn off and then turn on the Radical-7.
2. Use the Patient Cable connector on the Radical-7 to connect the Masimo SET Tester to the Radical-7.
3. See the directions for use that were provided with the Masimo SET Tester.

Nurse Call Test

To conduct a Nurse Call test

1. Disconnect any patient cables, sensors, or accessories from the Radical-7. Turn off the Radical-7 and then turn on again.
2. Ensure that there are no audible alarms and that the Audible Alarm feature is not set to silenced.
3. Verify the Nurse Call polarity is set to normal (default).
4. Connect the common lead of a digital multi-meter to the pin 12 (Nurse Call Common) of the Analog Output connector on the Radical-7. Connect the positive lead of the multi-meter to pin 6 (Nurse Call - Normally Open) of the Analog Output connector and measure that the resistance is greater than 1 MW (open circuit).
5. Trigger an alarm on the monitor (for example, by disconnecting a sensor after it was measuring data). Verify that the resistance is less than 35 ohms.

Analog Output Test

To conduct an Analog Output test

1. Disconnect any patient cables, sensors, or accessories from the Radical-7. Turn off the Radical-7 and then turn on again.
2. Connect the common lead of a digital voltmeter to the pin 2 (Ground) of the analog output connector on the Radical-7. Connect the positive lead of the voltmeter to pin 9 (Analog 1) of the analog output connector.
3. On the *device output* screen, on the *analog 1* option, select **0V Output**. See **Device Output** on page 76.
4. Verify that the voltmeter measures a voltage of approximately 0V.
5. Change the *analog 1* option to **1V Output**.
6. Verify that the voltmeter measures a voltage of approximately 1.0V.
7. Repeat steps 5 and 6, with the positive lead of the voltmeter connected to pin 15 (*analog 2*). See **Serial Interface Specifications** on page 115.
8. Connect a patient cable and sensor and verify that the voltage on pins 9 and 15 are between 0V and 1.0V while measuring a saturation and pulse rate.

Battery Test

To conduct a Battery test

1. Fully charge the Radical-7 by placing the Handheld into the Docking Station and then connect the AC power.
2. Verify that the Handheld Battery Charging indicator is illuminated.
3. When the Radical-7 is fully charged, the Handheld Battery Charging indicator turns off.
4. Turn on the Radical-7 on and verify that the Battery indicator shows a full charge.

Repair Policy

Masimo or an authorized Service Department must perform warranty repair and service. Do not use malfunctioning equipment. Have the instrument repaired.

Clean contaminated and/or dirty equipment before returning, following the cleaning procedure described in *Cleaning*. Make sure the equipment is fully dry before packing.

To return the instrument for service, see *Return Procedure on page 128*.

Return Procedure

Clean contaminated/dirty equipment before returning, following instructions in *Cleaning* on page 123. Make sure the equipment is fully dry before packing. Call Masimo at 800-326-4890 and ask for Technical Support. Ask for an RMA number. Package the equipment securely, in the original shipping container if possible, and enclose or include the following information and items:

- A letter describing in detail any difficulties experienced with the Radical-7. Include the RMA number in the letter.
- Warranty information, a copy of the invoice or other applicable documentation must be included.
- Purchase order number to cover repair if the Radical-7 is not under warranty, or for tracking purposes if it is.
- Ship-to and bill-to information.
- Person (name, telephone/Telex/fax number, and country) to contact for any questions about the repairs.
- A certificate stating the Radical-7 has been decontaminated for bloodborne pathogens.
- Return the Radical-7 to the shipping address listed in *Contacting Masimo* on page 129.

Contacting Masimo

To contact Masimo, refer to the following:

USA, Canada, and Asia Pacific	Europe	All Other Locations
Masimo Corporation 40 Parker Irvine, California 92618 (949) 297-7000 Fax: (949) 297-7001	Masimo International Sàrl Puits-Godet 10 2000 Neuchatel- Switzerland Tel:+41 32 720 1111 Fax: +41 32 724 1448	Contact your local Masimo Representative.

Warranty

Masimo warrants to the initial Purchaser for a period of one (1) year from the date of purchase that: (i) each new Product and the Software media as delivered are free from defects in workmanship or materials, and (ii) the Product and Software will perform substantially as labeled in the directions for use. Masimo's sole obligation under this warranty is to repair or replace any Product or Software that is covered under warranty.

Batteries are warranted for six (6) months.

To request a replacement under warranty, Purchaser must contact Masimo for a returned goods authorization. If Masimo determines that a Product must be replaced under warranty, it will be replaced and the cost of shipment covered. All other shipping costs shall be the responsibility of Purchaser.

Exclusions

The warranty does not extend to, and Masimo is not responsible for, repair, replacement, or maintenance needed because of: a) modification of the Product or Software without Masimo's written authorization; b) supplies, instruments or electrical work external to the Product or not manufactured by Masimo; c) disassembly or reassembly of the Product by anyone other than an authorized Masimo agent; d) use of the Product with sensors or other accessories other than those manufactured and distributed by Masimo; e) use of the Product and Software in ways or in environments for which they are not labeled; and f) neglect, misuse, improper operation, accident, fire, water, vandalism, weather, war, or any act of God. This warranty does not extend to any Product that has been reprocessed, reconditioned or recycled.

This warranty also does not apply to any Products provided to Purchaser for testing or demonstration purposes, any temporary Products modules or any Products for which Seller does not otherwise receive a usage or purchase fee; all such Products are provided AS-IS without warranty.

This warranty, together with any other express written warranty that may be issued by masimo is the sole and exclusive warranty as to the product and software. this warranty is expressly in lieu of any oral or implied warranties, including without limitation any implied warranty of merchantability or fitness for a particular purpose. masimo shall not be liable for any incidental, special or consequential loss, damage or expense directly or indirectly arising from the use or loss of use of any products or software. in no event shall masimo's

liability arising from any product and software (under contract, warranty, tort, strict liability or other claim) exceed the amount paid by purchaser for the products giving rise to such claim. the limitations in this section shall not be deemed to preclude any liability that cannot legally be disclaimed by contract.

Sales & End-User License Agreement

This document is a legal agreement between you ("purchaser") and Masimo corporation ("Masimo") for the purchase of this product ("product") and a license in the included or embedded software ("software") except as otherwise expressly agreed in a separate contract for the acquisition of this product, the following terms are the entire agreement between the parties regarding your purchase of this product. if you do not agree to the terms of this agreement, promptly return the entire product, including all accessories, in their original packages, with your sales receipt to masimo for a full refund.

Restrictions

1. **Copyright Restrictions:** The Software and the accompanying written materials are copyrighted. Unauthorized copying of the Software, including Software that has been modified, merged, or included with other software, or the written materials is expressly forbidden. Purchaser may be held legally responsible for any copyright infringement that is caused or incurred by Purchaser's failure to abide by the terms of this Agreement. Nothing in this License provides any rights beyond those provided by 17 U.S.C. §117.
2. **Use Restrictions:** Purchaser may physically transfer the Product from one location to another provided that the Software is not copied. Purchaser may not electronically transfer the Software from the Product to any other instrument. Purchaser may not disclose, publish, translate, release, distribute copies of, modify, adapt, translate, reverse engineer, decompile, disassemble, or create derivative works based on the Software or the written materials.
3. **Transfer Restrictions:** In no event may Purchaser transfer, assign, rent, lease, sell, or otherwise dispose of the Product or the Software on a temporary basis. Purchaser shall not assign or transfer this License, in whole or in part, by operation of law or otherwise without Masimo's prior written consent; except that the Software and all of Purchaser's rights hereunder shall transfer automatically to any party that legally acquires title to the Product with which this Software is included. Any attempt to assign any rights, duties or obligations arising hereunder other than as set forth in this paragraph shall be void.
4. **U.S. Government Rights:** If Purchaser is acquiring Software (including the related documentation) on behalf of any part of the United State Government, the following provisions apply: the Software and documentation are deemed to be "commercial software" and "commercial computer software documentation," respectively pursuant to DFAR Section 227.7202 FAR 12.212, as applicable. Any use, modification, reproduction, release, performance, display or disclosure of the Software (including the related documentation) by the U.S. Government or any of its agencies shall be governed solely by the terms of this Agreement and shall be prohibited except to the extent expressly permitted by the terms of this Agreement.

Appendix: Best Practices for Comparisons to Reference Measurements

Best Practices Checklist for Continuous SpHb Comparisons

- Ensure SpHb device is turned on. If applicable, connect to computer with automatic data capture.
- Sensor site selection:
 - Remove anything from patient's arm that can impede blood flow to the sensor site, such as restrictive garments, accessories, purses, backpacks, watches, jewelry, and blood pressure cuff.
 - Do not use sites with any of the following conditions:
 - An anatomically abnormal finger (e.g. damaged, clubbed, deviated, etc.).
 - A finger or arm that has experienced previous surgical procedures.
 - A finger or arm that is currently receiving an IV infusion.
 - A finger or arm that is currently used for blood pressure cuff.
 - Site should be cleaned of debris and dry prior to testing.
 - Nail polish should be removed prior to testing.
 - Select the patient's testing finger in the following priority:
 - Non-dominant ring or middle finger.
 - Dominant ring or middle finger.
- Sensor selection:
 - For reusable sensors, measure the patient's finger size (diameter) at the cuticle, using the sensor size gauge, to determine the correct sensor size.
 - When using ReSposable sensors, connect the reusable optical sensor (ROS) to the disposable optical sensor (DOS) after DOS properly placed onto finger.
- Ensure proper sensor positioning:
 - Rest patient's hand and arm with sensor on a horizontal surface securely to limit the movement of the patient.
 - Examine the finger while placed in the sensors to ensure the emitter and detector are directly aligned on top of each other and there is no gap between the sensor and fingertip.

- Align upper and lower red lines.



- If using a reusable sensor, make sure finger tip is inserted all the way and touching the finger stop inside the sensor (allowing long finger nails to extend beyond the finger stop).

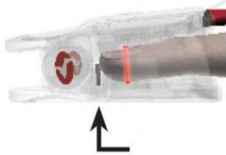

- Ensure cable runs flat over the top of the hand directly in the middle of the finger with no kinks or twists so the cable does not pull on the sensor.
- Cover sensor with Masimo-provided shielding to avoid light interference.



- Secure sensor cable to patient's arm with tape.
 - Instruct subjects to remain still without any sensor movement.
 - Connect sensor cable to device without pulling on sensor.
 - Wait until SpHb measurement is stable (one minute) before recording SpHb values.
 - Note any Low SIQ message that displays during measurement.
- Blood sampling and laboratory analysis:
- Record site of blood draw.
 - Document exact time blood withdrawn from patient.
 - When taking blood sample from arterial line, remove adequate dead space to ensure blood sample is not diluted with solution to keep arterial line open. When IV line set-up includes stopcocks, ensure that no fluid is infused through the line from which you are taking the blood. Draw blood directly into the vacutainer, if possible.
 - Mix blood carefully after filling the vacutainer by rotating it gently at least 10 times. (A rotation is one turn of the tube upside down and then right side up.)
 - All blood samples must be analyzed on the same calibrated laboratory hematology analyzer (Coulter, Sysmex, or equivalent) to avoid variation induced by the use of multiple laboratory devices.

Best Practices Checklist for SpCO Comparisons

- Ensure SpCO device is powered on and connected to computer with automatic data capture.
- After venous blood draw, SpCO testing *must* be initiated within 30 seconds (COHb can change rapidly).
- Sensor site selection:
 - Remove anything from patient's arm that can impede blood flow to the sensor site, such as restrictive garments, accessories, purses, backpacks, watches, jewelry, and blood pressure cuff.
 - Do not use sites with any of the following conditions:
 - An anatomically abnormal finger (e.g. damaged, clubbed, deviated, etc.).
 - A finger or arm that has experienced previous surgical procedures.
 - A finger or arm that is currently receiving an IV infusion.
 - A finger or arm that currently used for blood pressure cuff.
 - Site should be cleaned of debris and dry prior to testing.
 - Nail polish should be removed prior to testing.
 - Select the patient's testing finger in the following priority:
 - Non-dominant ring or middle finger.
 - Dominant ring or middle finger.
- Sensor selection:
 - Use the appropriate sensor as defined in the sensor directions for use.
- Ensure proper sensor positioning:
 - Rest patient's hand and arm with sensor on a horizontal surface securely to limit the movement of the patient.
 - Examine the finger while placed in the sensors to ensure the emitter and detector are directly aligned on top of each other and there is no gap between the sensor and fingertip.
 - Align upper and lower red lines.
 - If using a reusable sensor, make sure finger tip is inserted all the way and touching the finger stop inside the sensor (allowing long finger nails to extend beyond the finger stop).

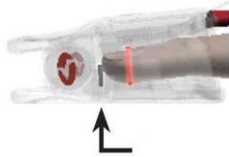

- Ensure cable runs flat over the top of the hand directly in the middle of the finger with no kinks or twists so the cable does not pull on the sensor.
- Cover sensor with Masimo-provided shielding to avoid light interference.



- Secure sensor cable to patient's arm with tape.
- Instruct subjects to remain still without any sensor movement.
- Connect sensor cable to device without pulling on sensor.
- Wait until SpCO measurement is stable (one minute) before recording SpHb values.

Note any Low SIQ messages that display during measurement.

Best Practices Checklist for Acoustic Respiration Rate Comparisons

Acoustic Sensor placement

- The Acoustic sensor has a small black arrow on the front (item 1 in figure below), when placing the sensor the black arrow should point forward to the anterior of subject's body.

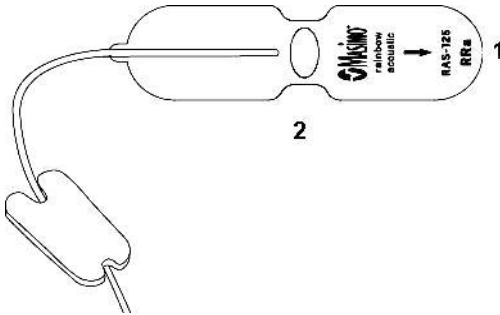

- Ensure placement site is hair-free, clean of debris, and dry prior to sensor placement. Use an alcohol swab to clean the neck area, if needed.
- The sensor pad (item 2 in the figure above) should be placed to either side of the larynx, in the area just above the thyroid cartilage and below the jaw line (see figure below). Ensure that there are no skin folds under the sensor pad.

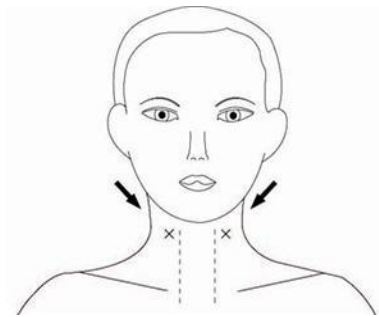

- For pediatric subjects that have limited neck space, the sensor may be placed on the right side of chest, underneath clavicle. The sensor should not be touching the clavicle.
- Place sensor tape on skin. Gently press on sensor tape from center outward so adhesive forms a good contact with patient's skin. Ensure there are no skin folds or air gaps under sensor pad.
- Remove the release liner from the anchor pad and place the anchor pad on patient's side of the neck; route the sensor cable in front of patient. Do not place anchor pad on clothing.

Pulse-Oximeter Sensor Placement

- Place finger sensor on middle or ring finger of hand opposite the blood pressure cuff.
- For reusable sensors, make sure the fingertip just touches the rubber stopper at the end of the sensor without going over it.
- Ensure sensor is right side up with the cable running in line with finger, not at an angle on dorsal (back side) of hand.

Monitoring

- Ensure RRA device is turned on and connected to computer with automatic data capture.
- Connect sensor to cable.
- If RRA values are not displayed after 2 minutes or if the RRA value has dropped out, check the following:
 - Confirm appropriate sensor placement, orientation and site selections.
 - Confirm that optical pulse-oximeter sensor is placed properly on the patient's finger.
 - Confirm that all cables are plugged in at each of the various connection points and hubs.
 - Auscultate with stethoscope to listen for air sounds on the side opposite sensor. If breath sounds are present, remove sensor and replace with new sensor on opposite side of neck.
 - Change the sensor out if RRA value continues to not display.
 - Verify that there is not excessive hair or a gap between the sensor and the neck and that it is placed.
- Simultaneously record the RRA and respiratory rates and from other methods. If comparing RRA to capnography respiration rate, a mask is recommended. Sidestream methods with a nasal cannula are not recommended because of dilution effect in the supplemental flow of gasses, inability to measure both nasal and oral airflow, and nasal cannula mispositioning. When recording values, confirm that there are no SIQ messages displayed on the device.
- Suggested directions to record manual respiration rate are as follows:
 - Use stethoscope to listen for breath sounds, count each breath cycle as one breathe, count for 60 seconds.

- Alternate method to stethoscope, count the number of chest rises/inhalations during a 60 second period. Record manual respiration rate to compare with RRa.
- Adjust respiratory pause settings as necessary, default is 30 seconds (options are: 15, 20, 25, 30, 35, or 40 seconds).
- Document patient events and time of event (based on computer clock). Include events that may affect performance, these include:
- Patient talking, picking at the sensor or nasal cannula, excessive movement, ambient noise present, fans or air blowing at sensor
- Inaccurate measurements may be caused by:
- Excessive ambient or environmental noise (patient speaking, room noise)
 - Improper sensor placement
 - Cable disconnection
 - Movement, picking, or air blowing at sensor

Index

3

3D Alarms • 58, 97

A

About • 58, 87

About Alarms • 95

About Parameter Information • 60, 62, 63, 64, 65, 67, 68, 69, 87, 97, 98

About the Display View • 45, 48

About the Status Bar • 48, 49, 75, 76, 105

About this Manual • 7

About Trend Views • 77

Access Control • 46, 70, 71, 72, 90, 93

Accessing the Main Menu • 47, 49, 57

Accuracy • 109

Acoustic Waveform View • 54

Acquisition System • 31

Additional Settings for PI • 64, 65

Additional Settings for PVI • 67

Additional Settings for RRA • 65, 66

Additional Settings for SpHb • 62, 63

Additional Settings for SpO₂ • 60, 61

Alarm Limit Test • 126

Alarm Related Safety Information, Warnings, and Cautions • 19, 95

Alarms • 112

Alarms for SpO₂ • 60, 61

Analog Output and Nurse Call Specifications • 117

Analog Output Test • 127

Appendix

Best Practices for Comparisons to Reference Measurements • 106, 107, 131

B

Battery • 49, 71, 76

Battery Operation and Maintenance • 36, 42, 44, 76, 108, 123, 125

Battery Run Time Significantly Reduced • 108

Battery Test • 128

Best Practices Checklist for Acoustic Respiration Rate Comparisons • 136

Best Practices Checklist for Continuous SpHb Comparisons • 131

Best Practices Checklist for SpCO Comparisons • 134

Brightness • 71, 76, 107, 124

Buttons Do Not Work When Pressed • 108

C

Changing Between Trend Views • 79, 82

Changing Profiles • 56, 58, 90

Changing Sensitivity Modes • 56

Changing the Size of Parameter Values • 35, 48, 50

Changing the Time Interval of Trend Data • 81

Changing Trend Settings • 83

Chapter 1

Technology Overview • 23

Chapter 2

Radical-7 Descriptions • 33

Chapter 3

Setup • 41

Chapter 4

Operation • 45

Chapter 5

Profiles • 35, 45, 89

Chapter 6

Alarms and Messages • 95, 106, 107

Chapter 7

Troubleshooting • 95, 105

Chapter 8

Specifications • 109

Chapter 9

Service and Maintenance • 102, 104, 123

Citations • 120

Cleaning • 123, 128

Compliance • 114

Contacting Masimo • 107, 108, 128, 129

Continuous Speaker Tone • 108

Contraindications • 10

D

Deleting Trend Data • 85

Desat Index Alarm Overview • 97, 98

Desat Index Alarms • 97, 98

Desat Index Settings • 97

Device Output • 44, 71, 76, 127

Device Related Safety Information,
Warnings, and Cautions • 14, 42, 43,
44

Device Settings • 57, 71, 101, 116

Difficulty Obtaining a Reading • 107

Dimly Lit Parameters • 106

Display Indicators • 113

Docking Station Power Requirements •
41

E

Electrical • 111

Electrical Safety Information, Warnings,
and Cautions • 17, 42

Environmental • 41, 111

Estimated Run Times of Battery Power •
124

Exclusions • 129

F

FastSat Overview • 61, 64

Functional Oxygen Saturation • 24

Functionality of the Radical-7 • 34

G

General Description for
Carboxyhemoglobin (SpCO) • 29

General Description for Methemoglobin
(SpMet) • 30

General Description for Oxygen
Saturation (SpO2) • 24

General Description for Perfusion Index
(PI) • 25

General Description for Pleth Variability
Index (PVI) • 25

General Description for Pulse Rate (PR) •
25

General Description for SpOC • 29

General Description for Total Arterial
Oxygen Content (CaO2) • 29

General Description for Total
Hemoglobin (SpHb) • 28

General System Description • 33

H

Handheld • 35

Handheld Back Panel • 36

Handheld Battery Does Not Charge •
108

Handheld Front Panel • 35, 117

I

Incompatible Adhesive Sensor Message
• 100

Incompatible Cable Message • 104

Incompatible Sensor Message • 100

Indications for Use • 10

Indicators on Docking Station
Continuously Flash • 108

Initial Battery Charging • 42

Instrument Does Not Turn On • 107

Instrument Turns On But Screen is Blank
• 107

Interference Detected Message • 101

K

Key Features • 9

L

Localization • 49, 71, 74, 107
 Low Battery Message • 101
 Low Perfusion • 101, 106
 Low Perfusion Index Message • 101
 Low Signal IQ Message • 102
 Low Signal Quality • 106
 Low SpCO SIQ Message • 102
 Low SpHb SIQ Message • 102
 Low SpMet SIQ Message • 102

M

Manipulating Trend Data • 79
 Masimo rainbow SET Parallel Engines • 23
 Masimo SET DST • 24
 Measurement Range • 109
 Messages • 49, 99
 Monitor Interface With SatShare • 40

N

Navigating the Main Menu • 57
 Navigating the Radical-7 • 47
 No Adhesive Sensor Connected Message • 101
 No Cable Connected Message • 102
 No Sensor Connected Message • 103
 Nurse Call Test • 117, 127

O

Output Interface • 115

P

Parameter Quick Trend View • 55

Parameter Related Safety Information, Warnings, and Cautions • 11, 105

Parameter Settings • 58, 59

Patient • 31

Performance Verification • 126

Perfusion Index (PI) Delta Alarm Overview • 97, 98, 99

Perfusion Index (PI) Settings • 59, 64

Physical Characteristics • 112

PI Alarms • 64

PI Delta Alarms • 99

PI Delta Settings • 98

Pleth + Sig IQ + Acoustic View • 54

Pleth + Sig IQ View • 53

Powering Off the Radical-7 • 94

Power-On Self Test • 126

PR Alarms • 63

PR Settings • 59, 63

Product Description • 9

Product Description, Indications for Use, Contraindications, and Features • 9

Profiles Overview • 49, 89, 93

Pulse Bar • 52

Pulse CO-Oximetry vs. Drawn Whole Blood Measurements • 28

Pulse Search Message • 103

PVI Alarms • 67

PVI Settings • 59, 67

R

rainbow Acoustic Monitoring (RAM) Technology • 30

rainbow Acoustic Monitoring Architecture • 31

rainbow Pulse CO-Oximetry Technology • 26

Repair Policy • 128

Replace Adhesive Sensor Message • 100

Replace Cable Message • 100

Replace Sensor Message • 99

Replacing Factory Default Settings for
Adult and Neo Profiles • 93

Replacing the Batteries • 125

Replacing the Fuses • 107, 125

Resolution • 111

Respiration Rate (RR) • 59, 65

Restrictions • 130

Return Procedure • 41, 128

RRa Alarms • 65, 66

RRa Settings • 65

Run Time for Handheld Only • 124

S

Safety Information, Warnings, and
Cautions • 11, 28, 29, 30, 41, 95, 123

Sales & End-User License Agreement •
130

Screen Orientation • 71, 75

Sensitivity Modes Overview • 49, 55, 92

Sensor • 31

Sensor Initializing Message • 103

Sensor Off Patient Message • 103

Sensor Related Safety Information,
Warnings, and Cautions • 20

Serial Interface Setup • 116

Serial Interface Specifications • 39, 42,
43, 44, 115, 127

Service Required Message • 104

Setting Up and Using SatShare • 40, 44

Setting Up for Philips, Agilent, or HP
VueLink • 42

Setting Up for SpaceLabs Flexport • 43

Setting Up the Docking Station • 41

Signal Extraction Technology (SET) • 23

Signal IQ (SIQ) • 102, 105

Signal IQ Indicators • 52, 53

Signal Processing • 32

Silencing the Alarms • 35, 45, 93, 95

Sounds • 49, 58, 70, 73, 96

SpCO Alarms • 67, 68

SpCO Reading Displays as Dashes • 107

SpCO Settings • 59, 67

SpCO, SpMet, and SpHb Measurements
During Patient Motion • 30

Speaker Failure Message • 102

SpHb Alarms • 62

SpHb Settings • 59, 62

SpMet Alarms • 68

SpMet Settings • 59, 68

SpO2 Only Mode Message • 101

SpO2 Settings • 59, 60

SpO2 Values Do Not Correlate With
Clinical Assessment or Arterial Blood
Gas Measurements • 106

SpOC Alarms • 59, 69

SpOC Settings • 69

Standalone • 37

Standalone Back Panel • 39, 44, 76

Standalone Front Panel • 38, 42

Successful Monitoring for SpCO • 29,
102

Successful Monitoring for SpHb • 28,
102

Successful Monitoring for SpMet • 30

Successful Monitoring for SpO2, PR, and
PI • 24

Symbols • 119

T

Testing with the optional Masimo SET
Tester • 127

Trend Field • 51, 58

Trending • 112

Trends • 51, 58, 77

Troubleshooting Measurements • 28,
105

Troubleshooting the Radical-7 • 107

U

Unexpected SpO2, SpCO, SpMet, or
SpHb Reading • 106

Radical-7

Unexpectedly High SpCO Reading • 107

Unpacking and Inspection • 41

Using Screen Lock • 46

Using the Histogram Feature • 82

Using the Home Button • 46

Using the Touchscreen and Buttons • 45

W

Warranty • 129

Waveform and Trend Views • 48, 52

WiFi • 49, 71, 75

Wireless Radio (If Installed) • 115



35322/LAB-5475E 0912